

Portfolio
ID Capstone ID-
250
Pourchista Shahi



Section 1: Hand Drawings

Skills:

- Markers: Blending, shading, and rendering techniques
- Perspective Drawing: One-point, two-point, and three-point perspective
 - Line Work: Precision drafting, contour drawing, and cross-hatching enduring

Techniques: Light and shadow, texture depiction, and atmospheric perspective

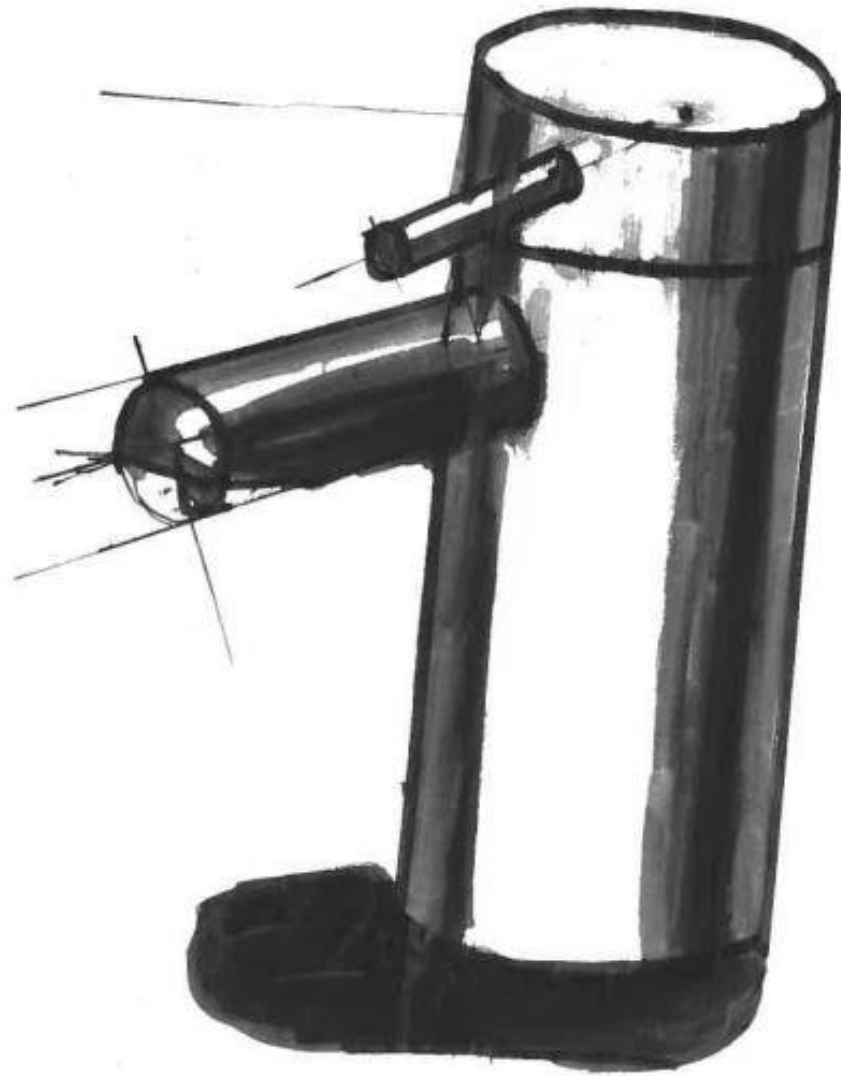

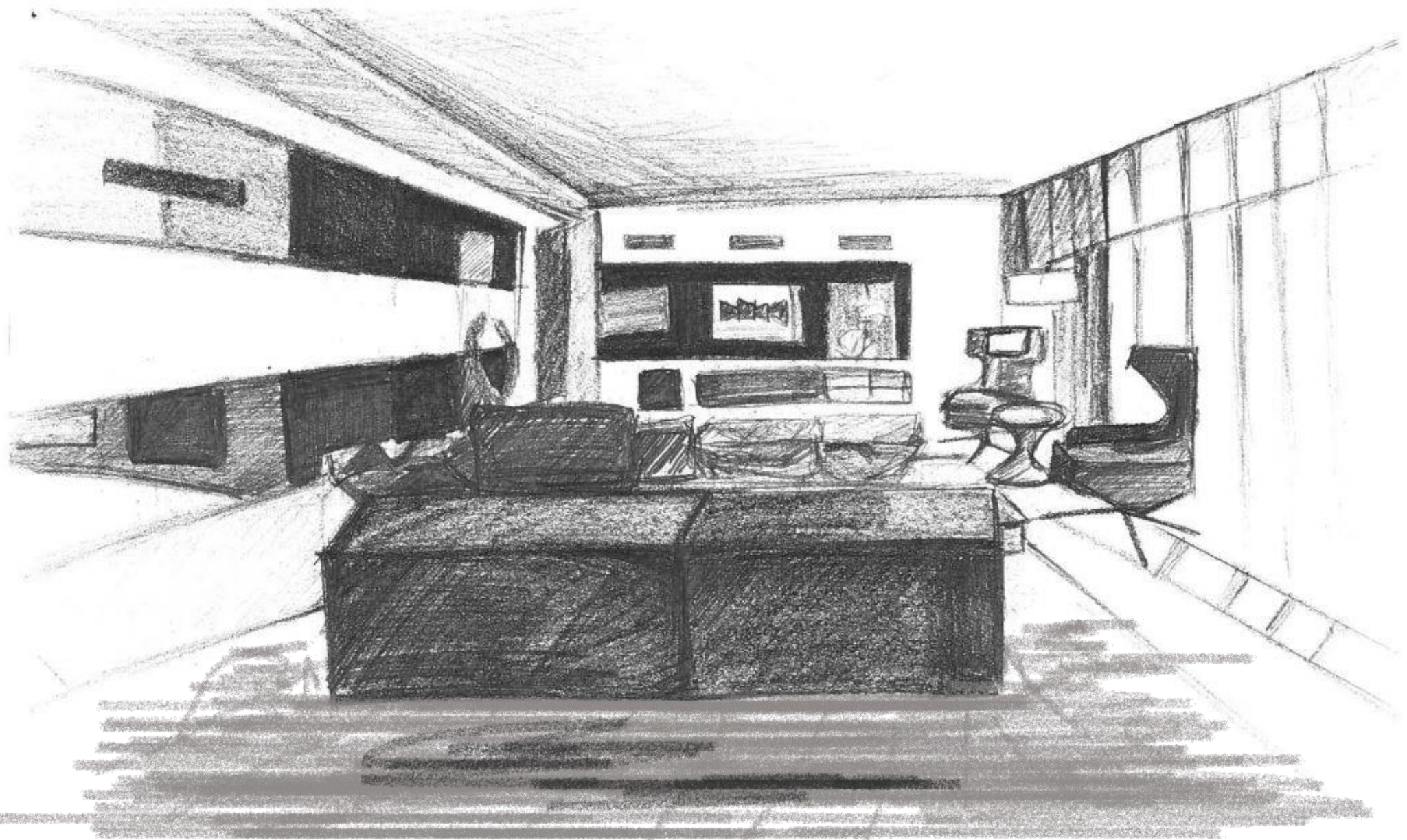

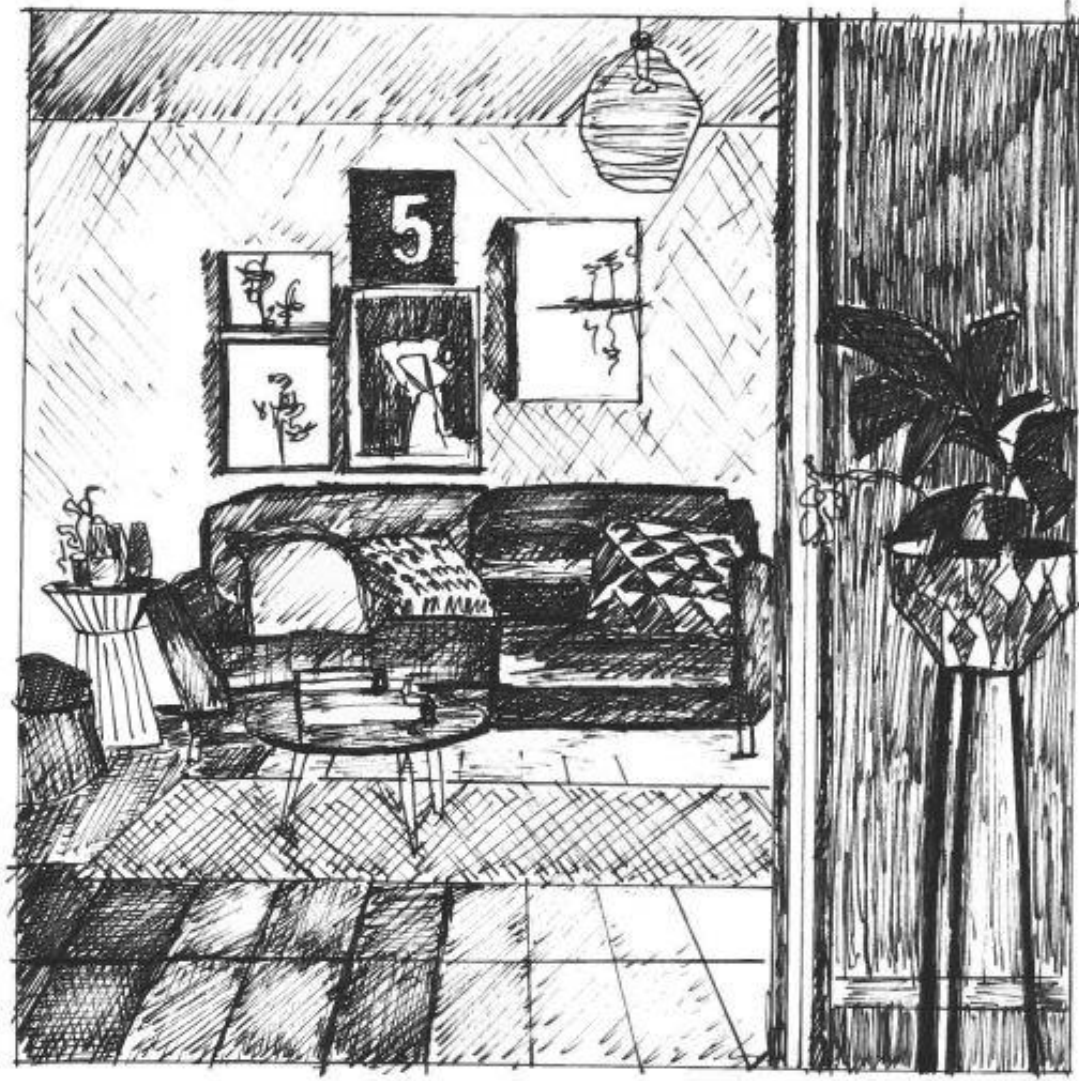







Section 2
Hand Drafting :
ELEVATIONS
STAIRDETAILS
FLOORPLANS
BUILDIGSECTIONS
SITEPLAN



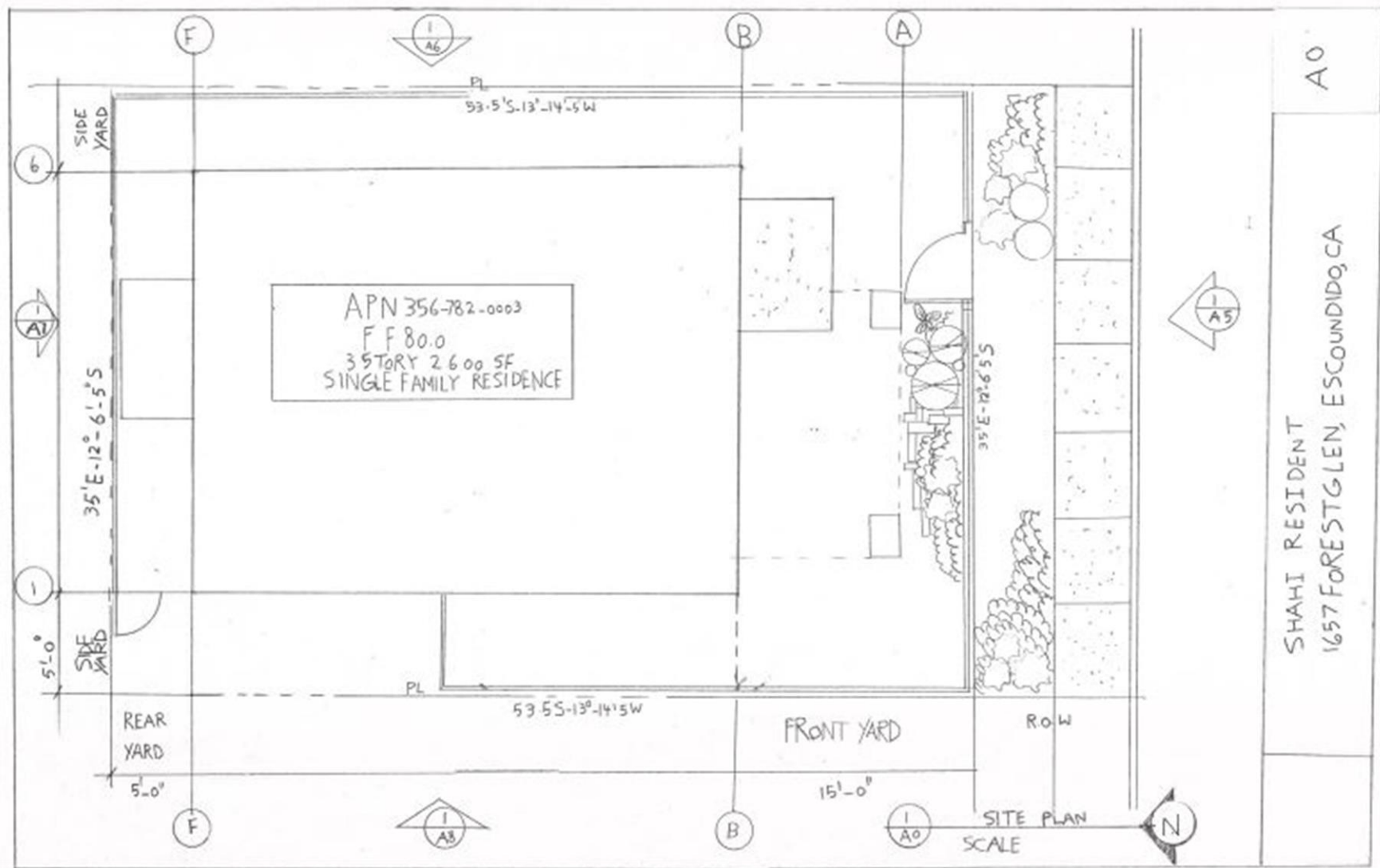

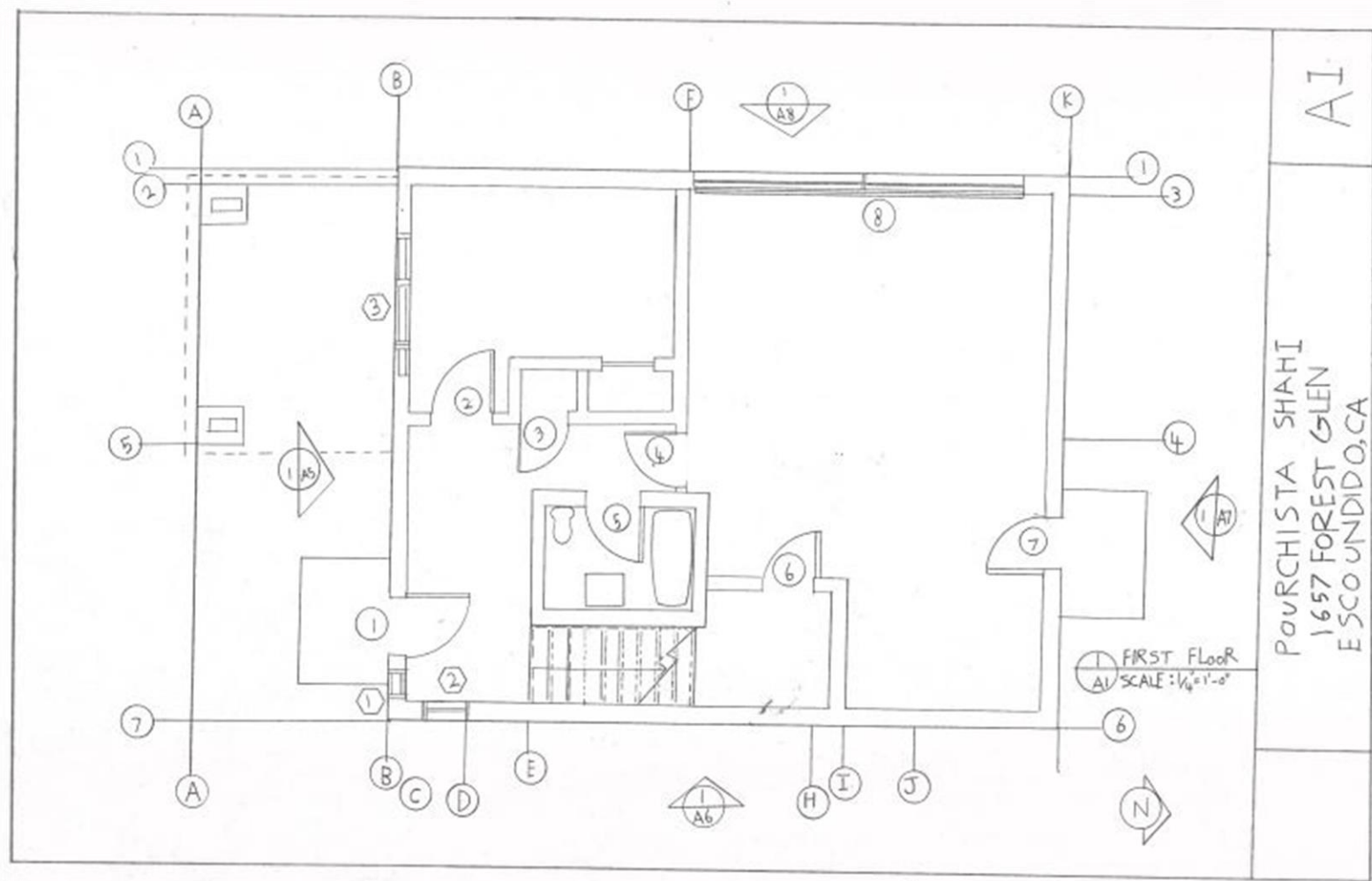

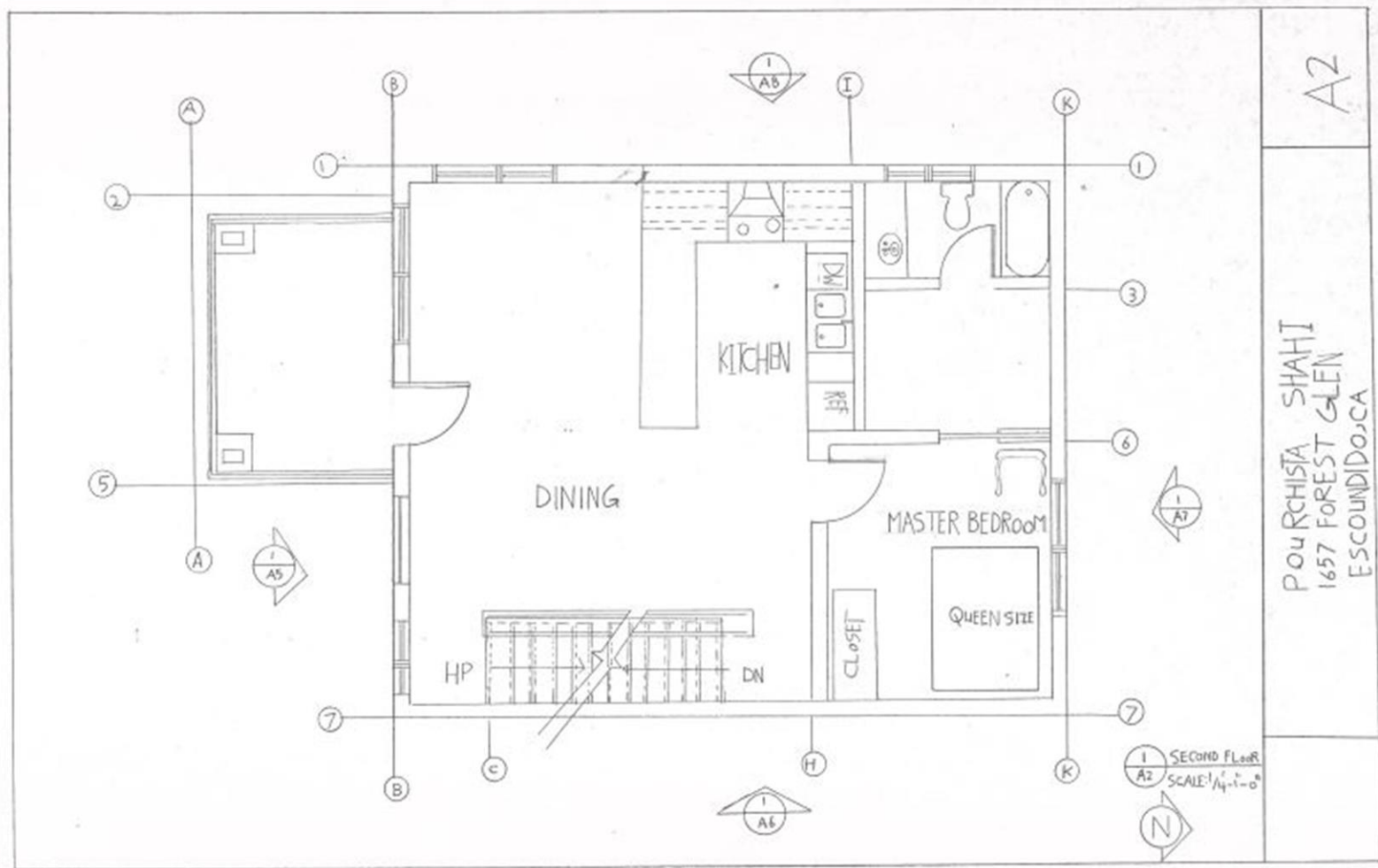

POURCHISTA SHAHI
 1657 FOREST GLEN
 ESCUNDIRIDO, CA

A2

1 SECOND FLOOR
 A2 SCALE: 1/4" = 1'-0"

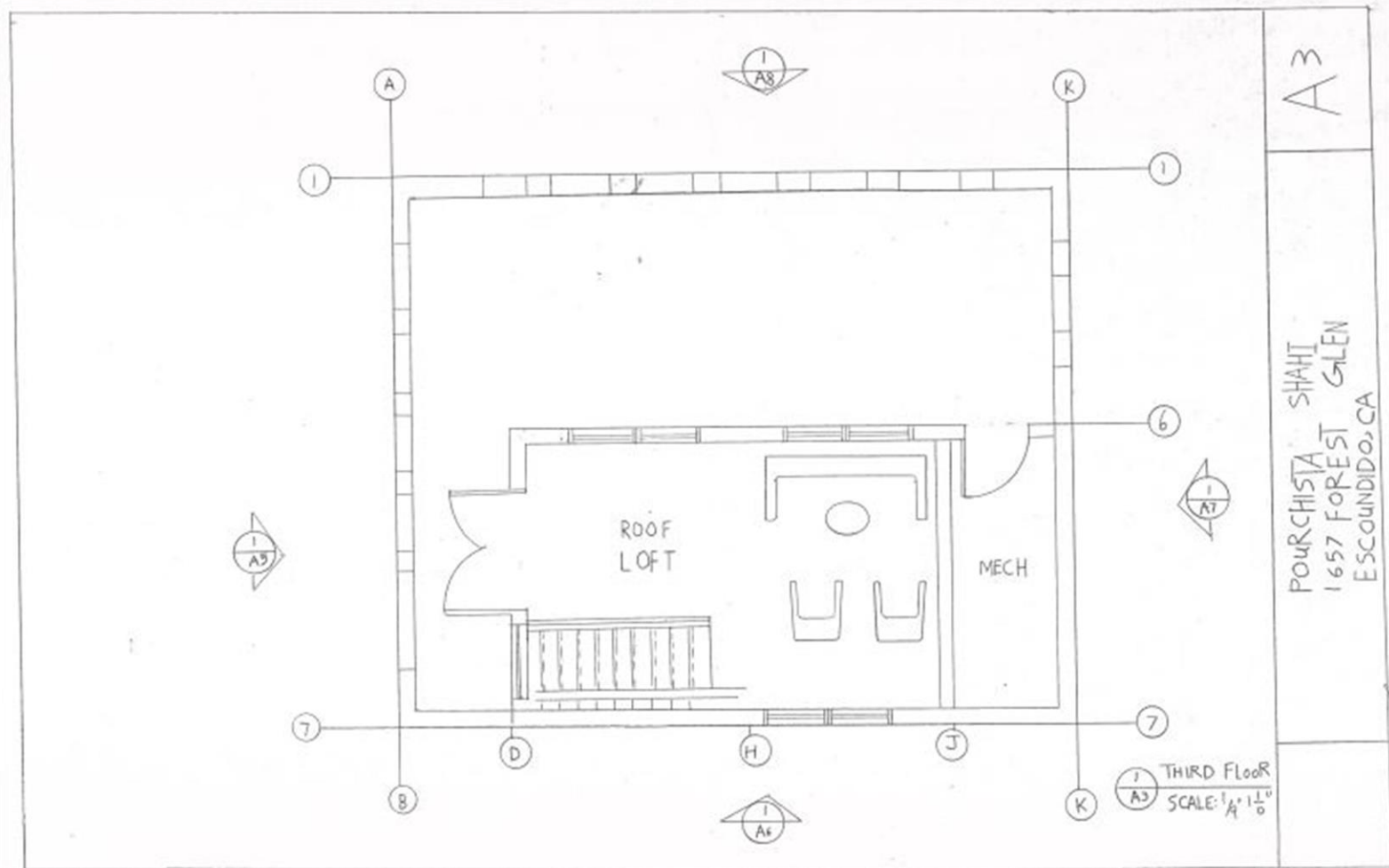

A3

POURCHISTA SHAHI
 1657 FOREST GLEN
 ESCONDIDO, CA

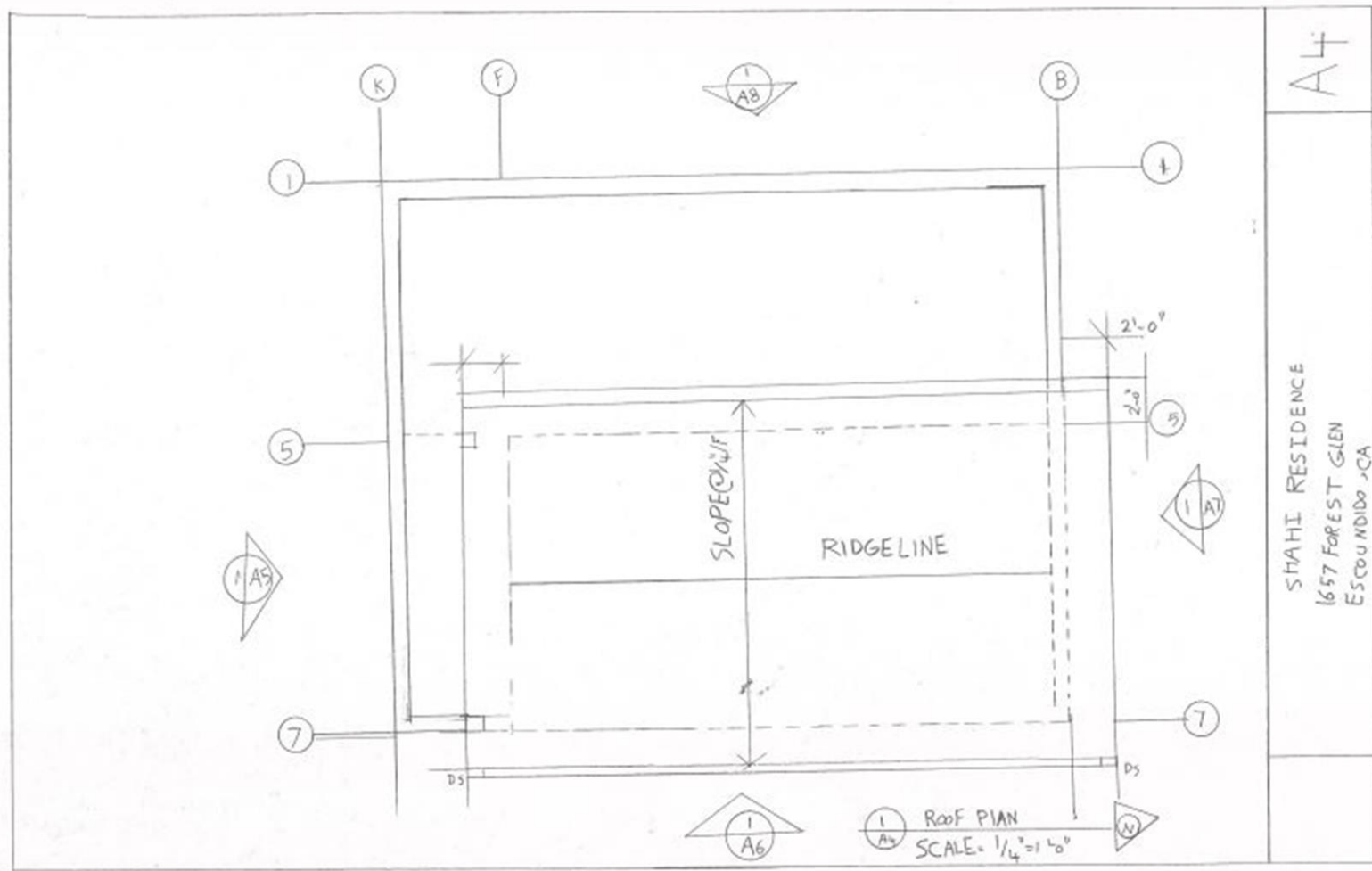

A4

SHAHI RESIDENCE
 1657 FOREST GLEN
 ESCOBIDO, CA

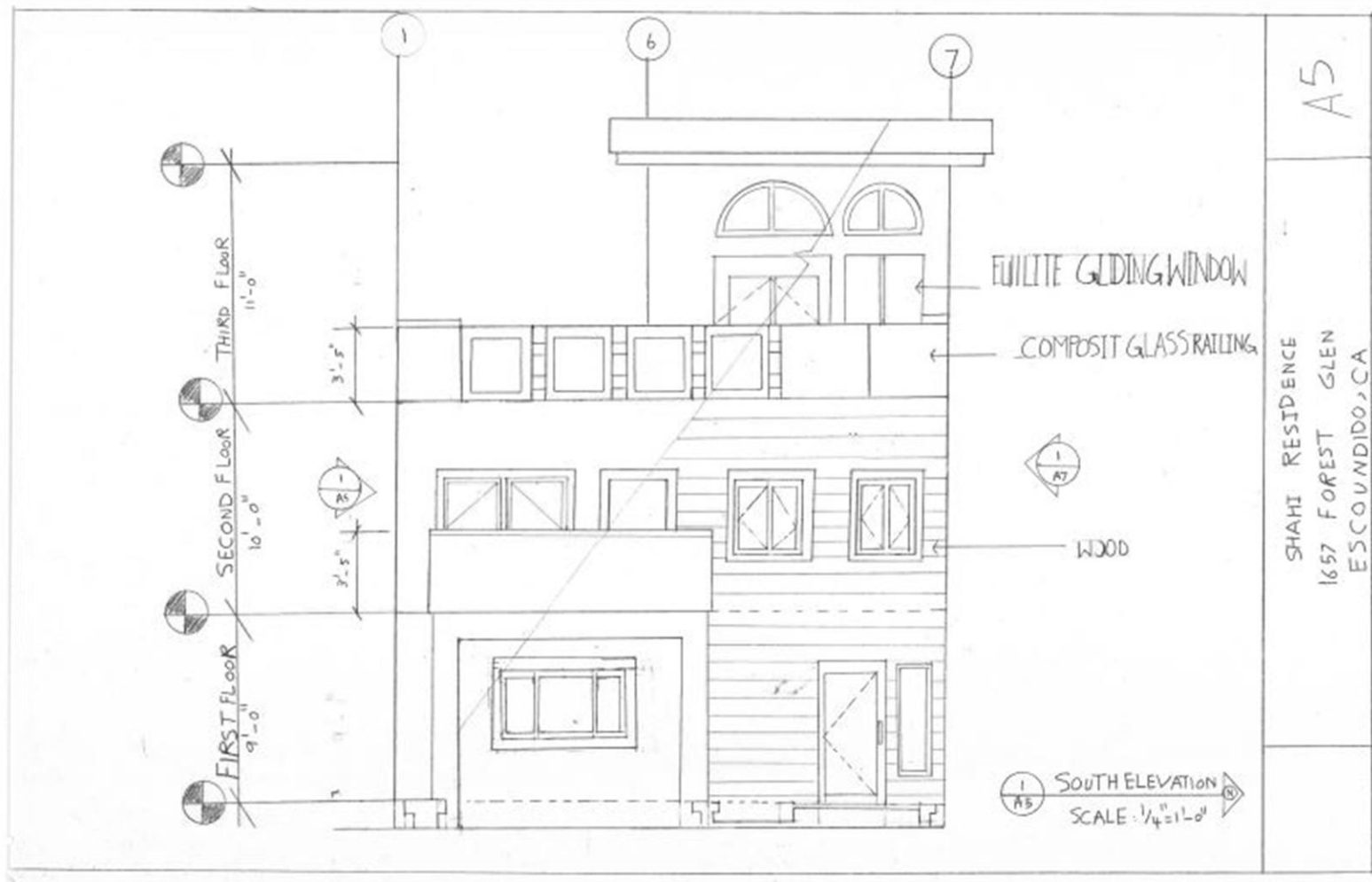

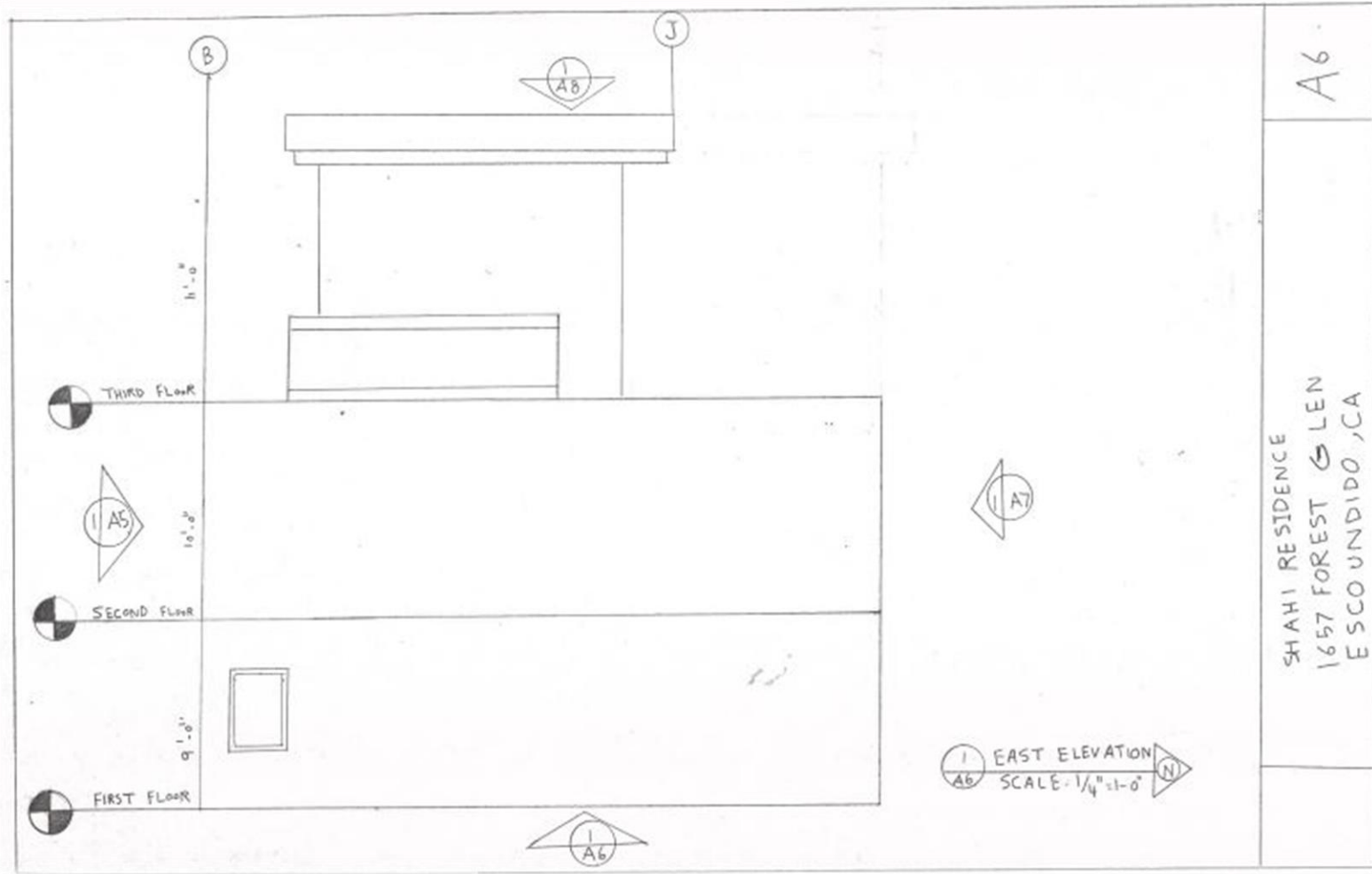

SHAHI RESIDENCE
 1657 FOREST GLEN
 ESCONDIDO, CA

A6

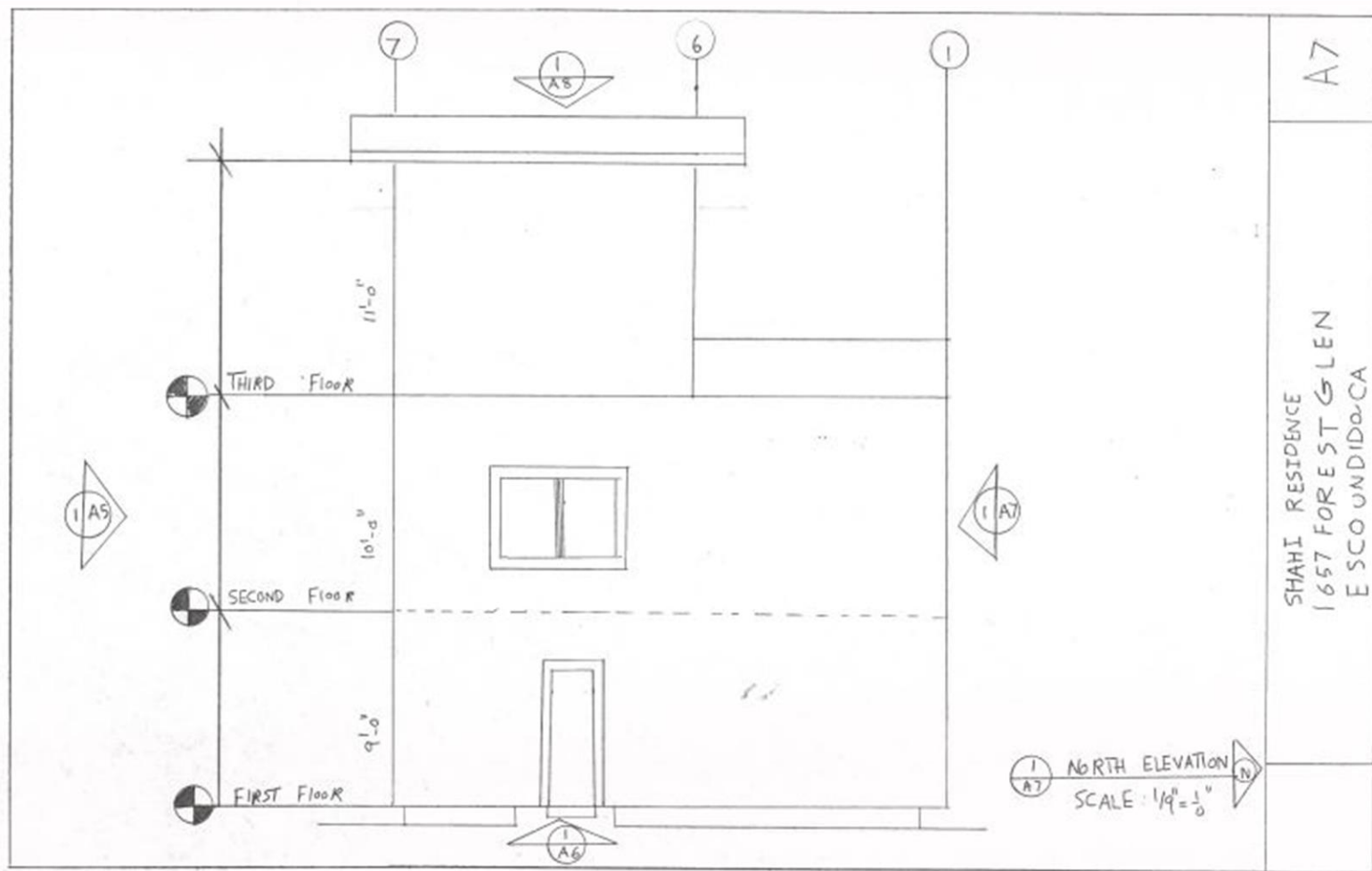



SHAHI RESIDENCE
 1657 FOREST GLEN
 ESCO UNIDIDO, CA

A8

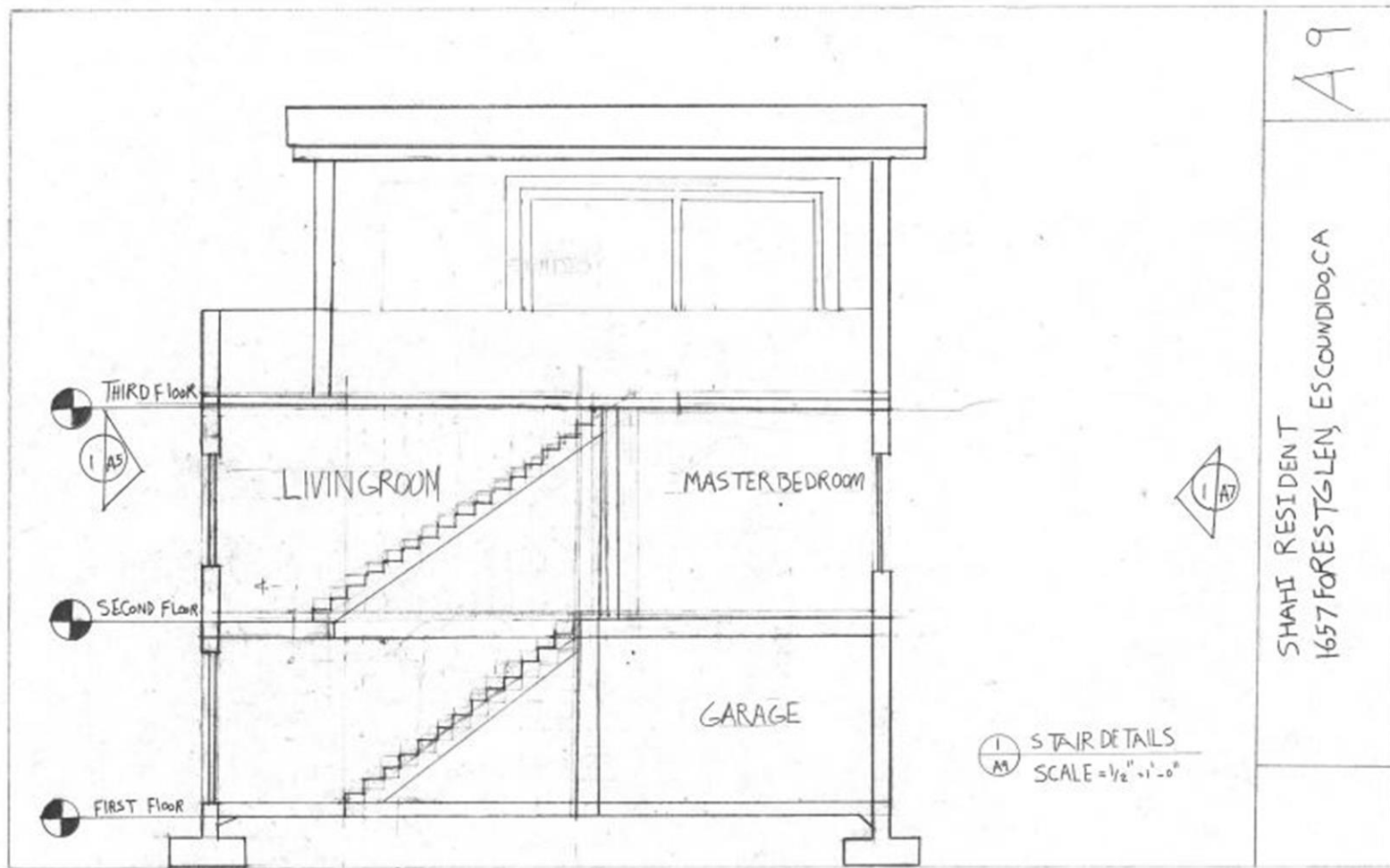

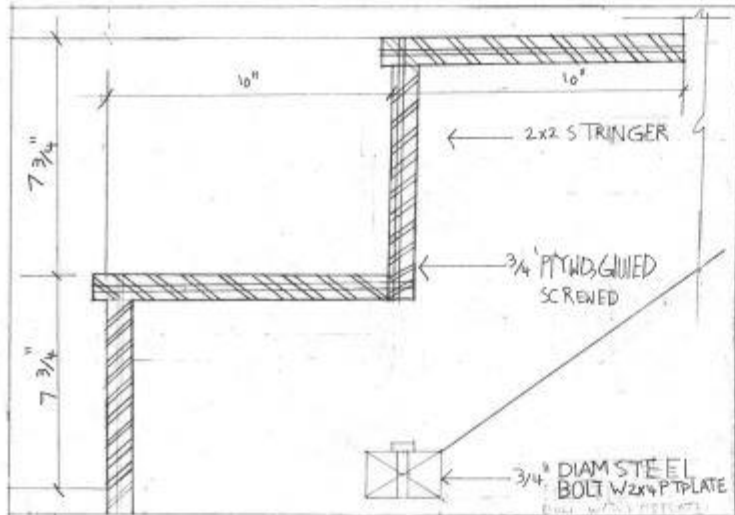

2 STRINGER TO FLOOR DETAIL SCALE: 3/8"=1'-0"

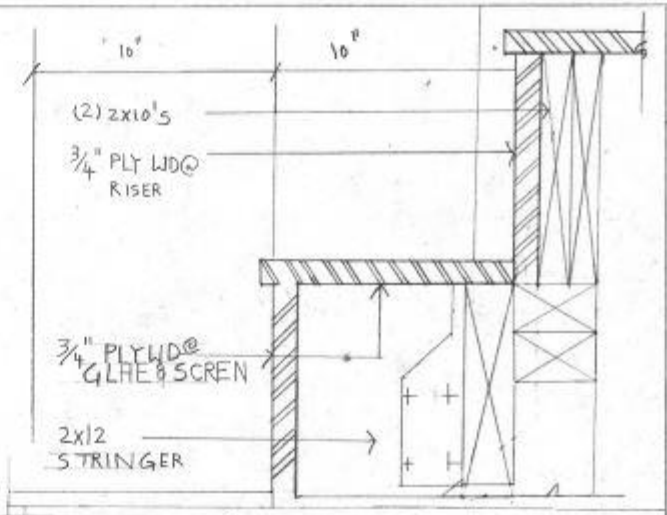

1 STRINGER TO LANDING DETAIL SCALE: 3/8"=1'-0"

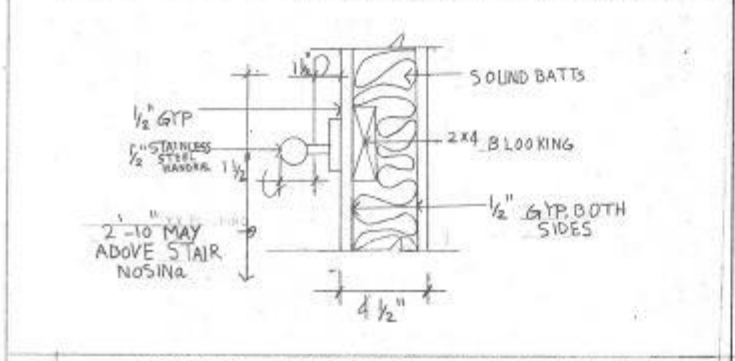

3 TYPICAL HANDRAIL @ 1-ALL SCALE: 3/8"=1'-0"

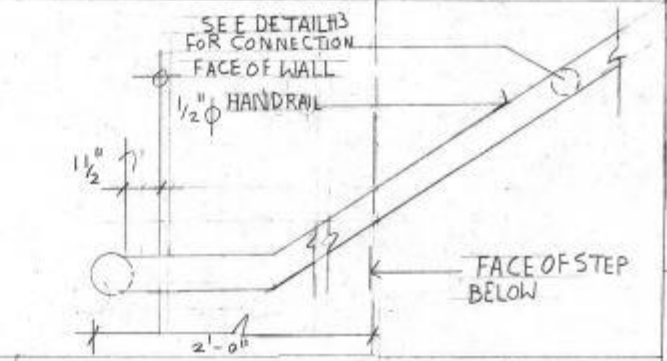

4 HANDRAIL TERMINATION SCALE: 3/8"=1'-0"

AIR

SHAHI RESIDENCE
1657 FOR EST GLEN
ESCONDIDO, CA



POURCHISTA SHAHI - 02/06/24 - ARCH 105

Section3:
Sketch up
AutoCAD,
Design 2020 kitchen
&Bath
Revit
Commercial Design
Project
3D Art panel



Sushi Bar

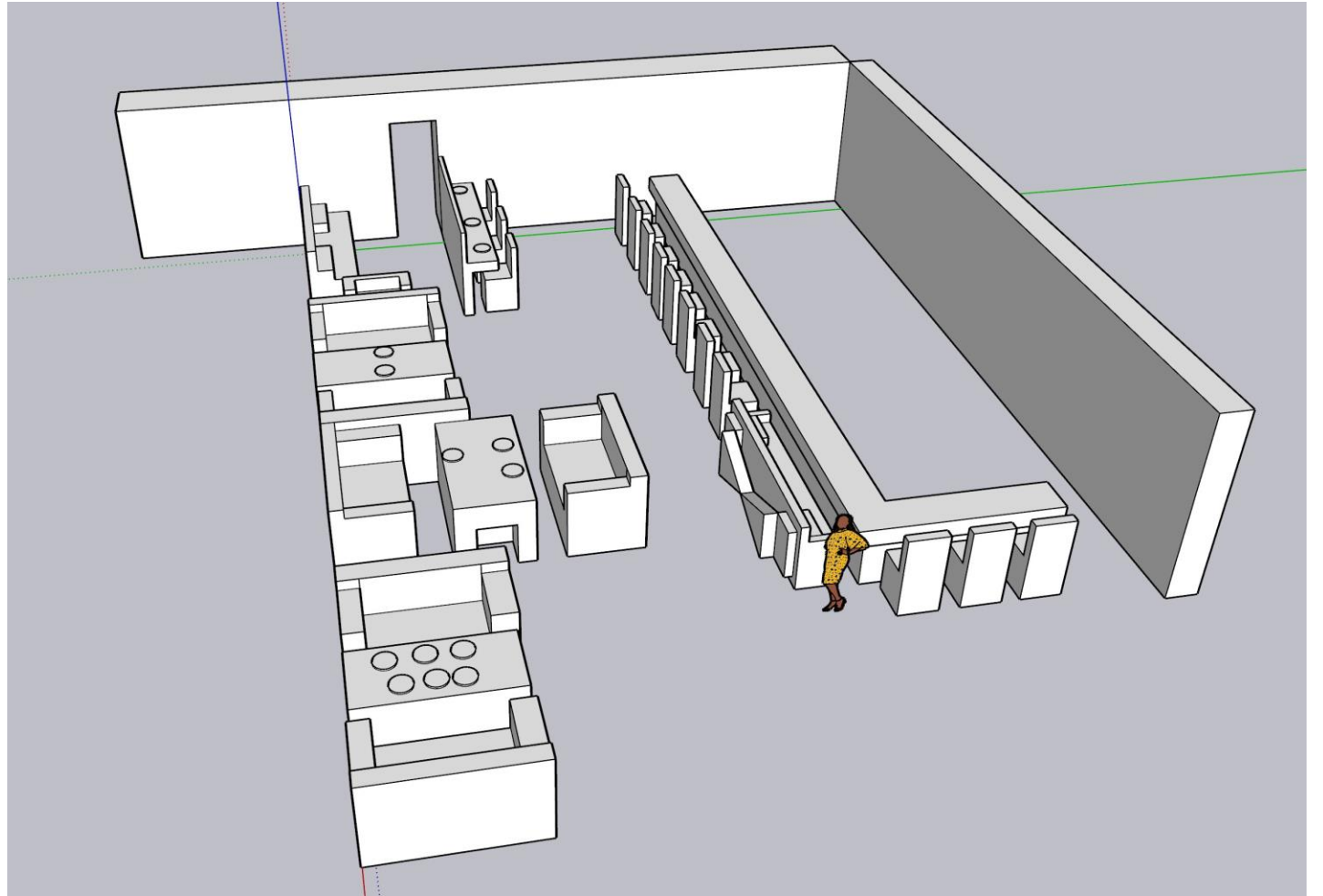

Hotel Lobby

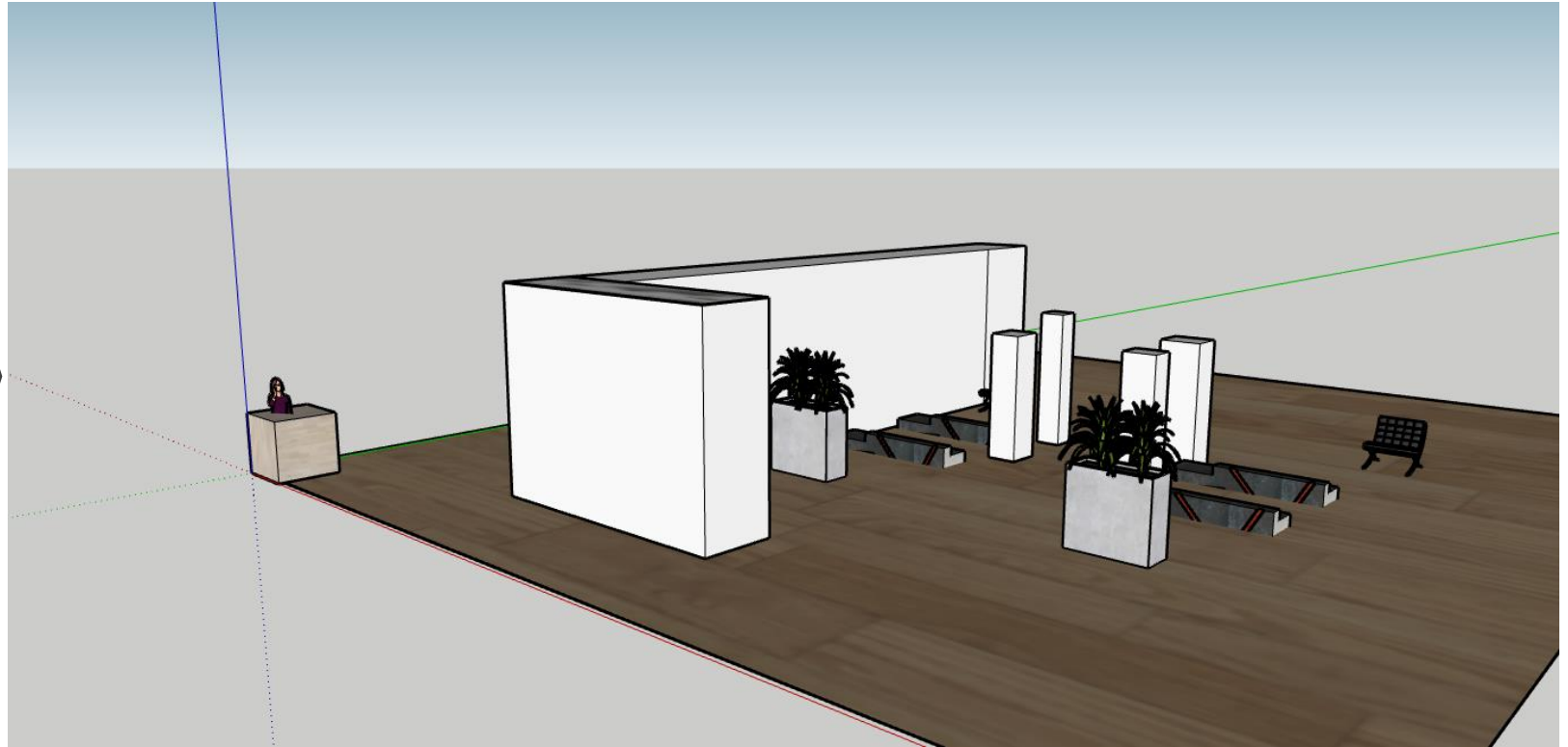

AutoCAD



[+][Top][2D Wireframe]

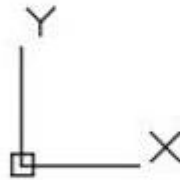
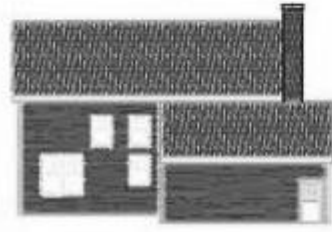

south
and
west
Elevation

NAME: Pourahita shan

CLASSID 158

DATE: 04/07/24

SHEET NO.

A-1

[+][Top][2D Wireframe]

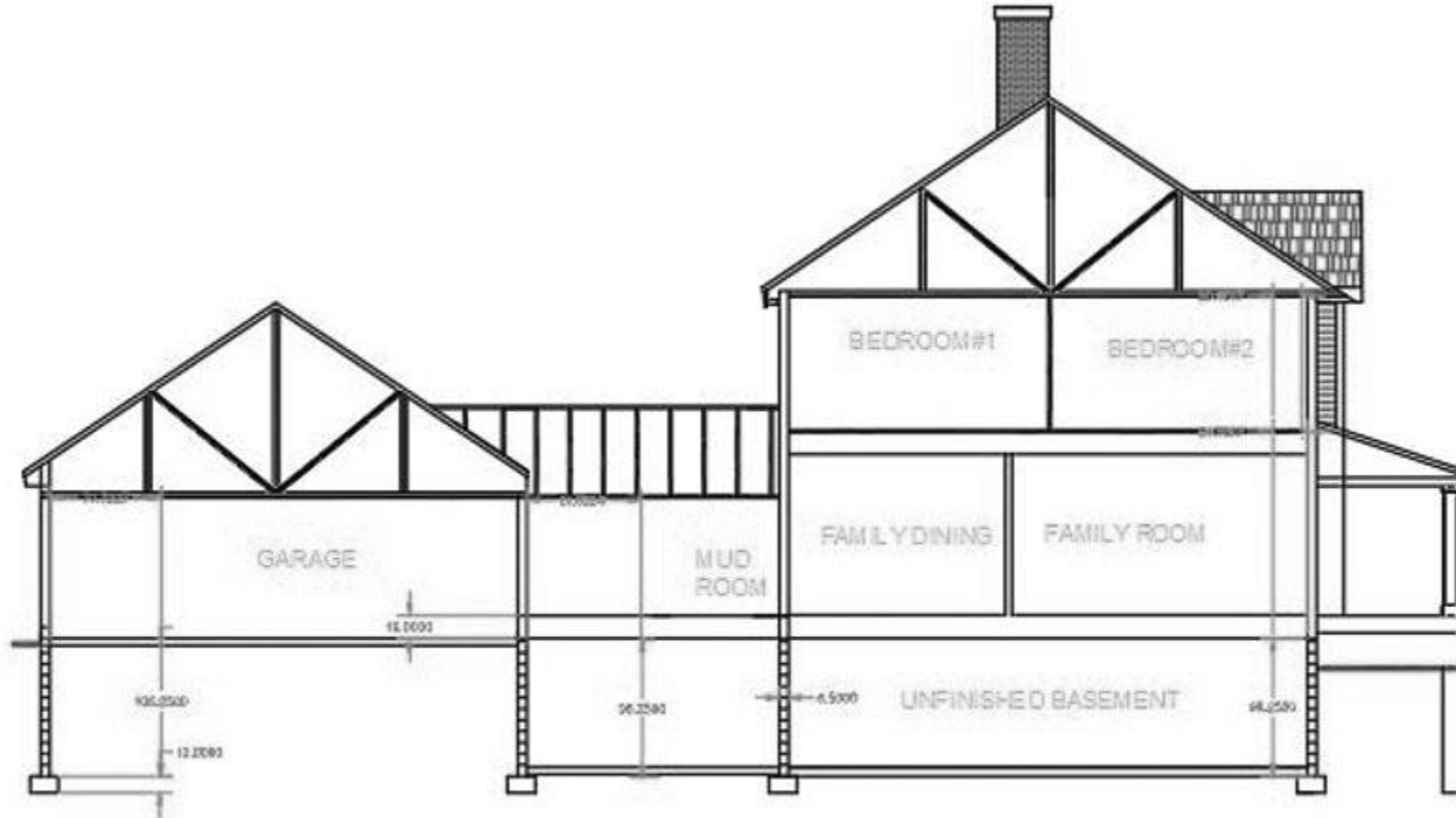

Navigation controls including a compass with N, S, E, W directions, a 'TOP' button, a 'WCS' dropdown menu, and a zoom icon.

A vertical toolbar containing various icons for editing and viewing the model, such as pan, rotate, and zoom.



BUILDING SECTION ENLARGED

NAME: Pourchista shah
CLASS: ID 150
DATE: 04/14/24
SHEET NO.
A-1

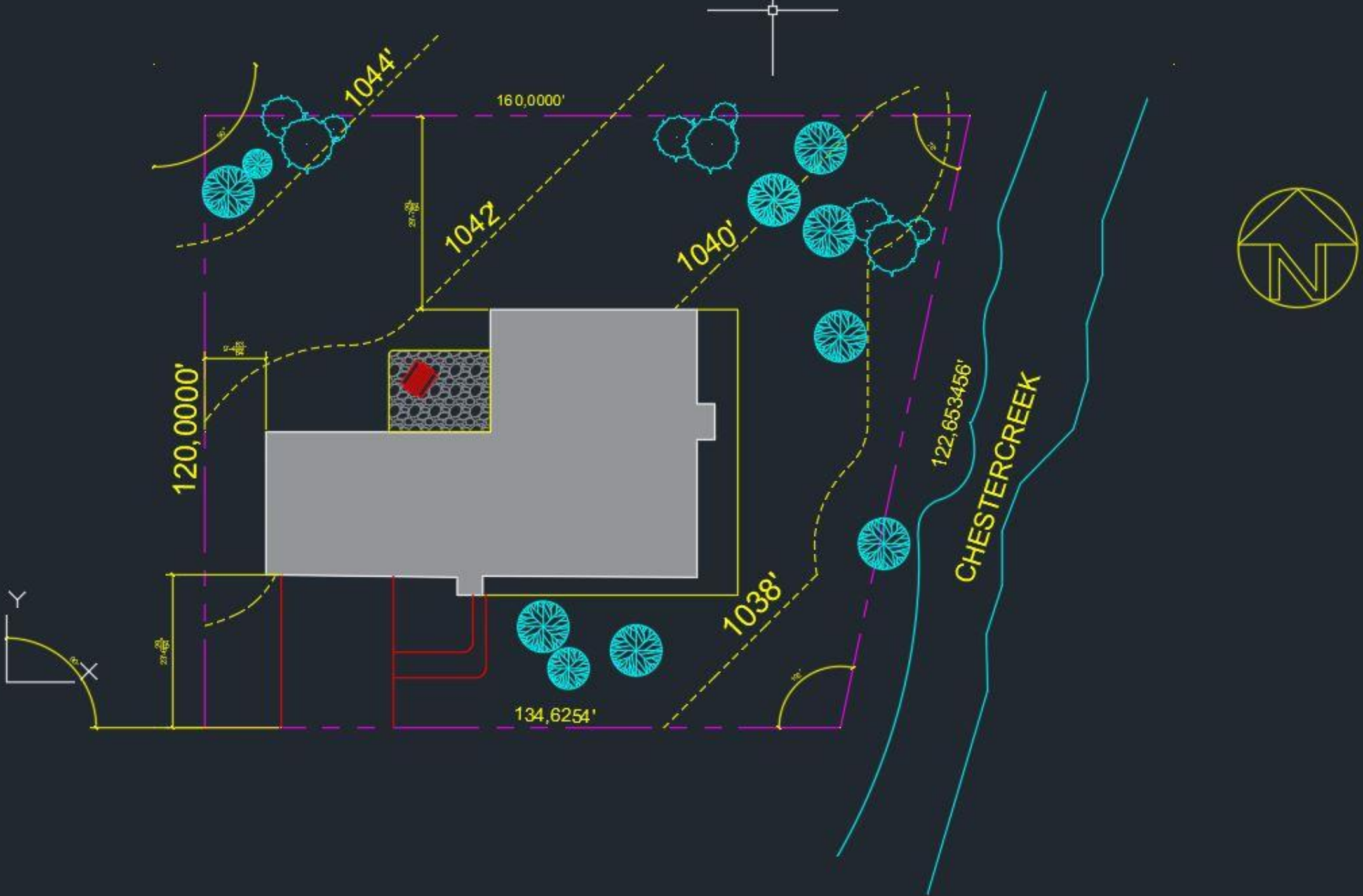

[+][Top][2D Wireframe]

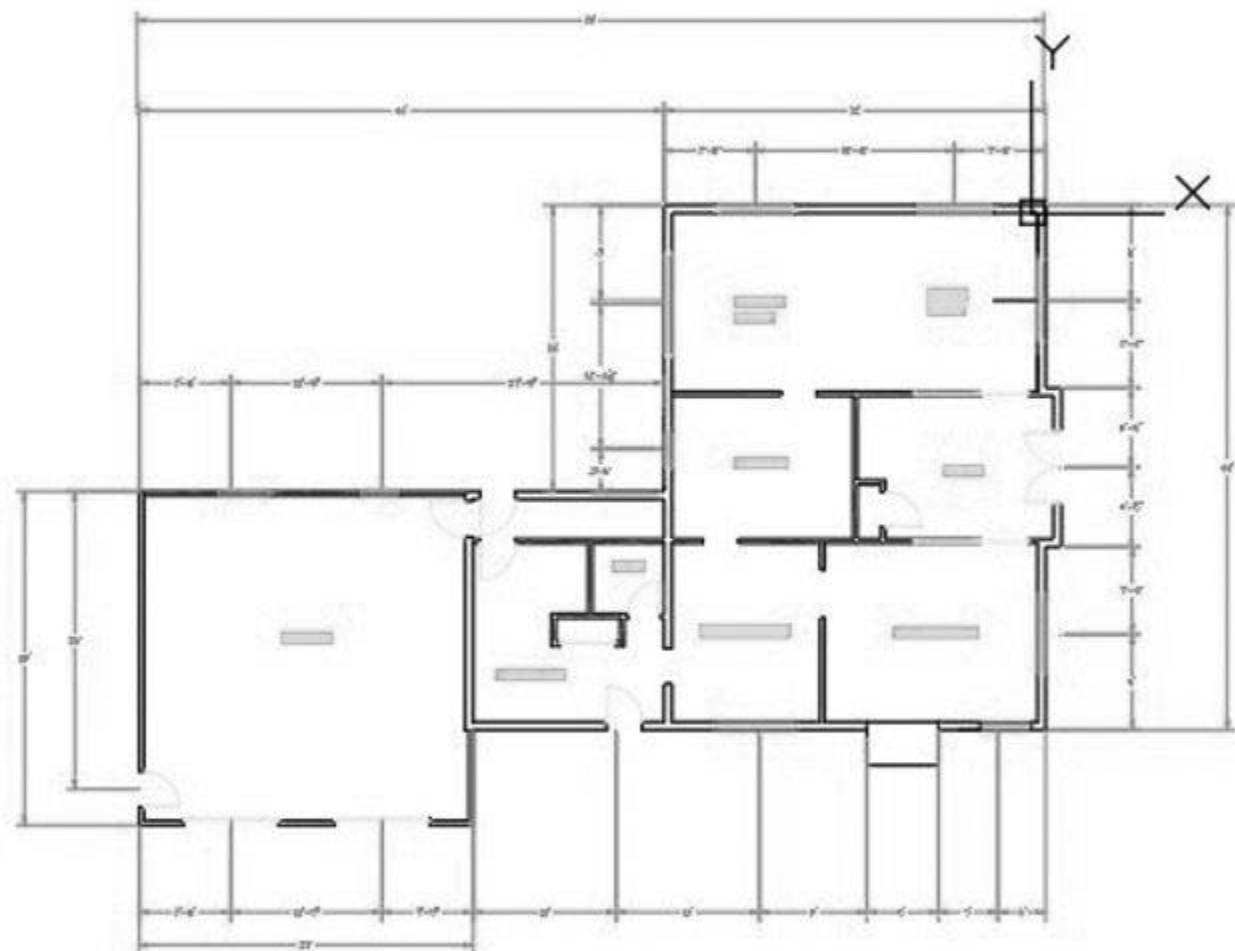

Navigation controls including a compass with 'N', 'S', 'E', 'W' directions, a 'TOP' button, and a 'WCS' dropdown menu.

A vertical toolbar containing various icons for navigation and editing, such as a hand, a mouse, and a selection tool.

TITLE
BLOCK, FIRST
FLOOR

NAME: panchisla
Shah

CLASS: ID 150

DATE: 03/20/2024

SHEET NO: A1

A-1

[+][Top][2D Wireframe]

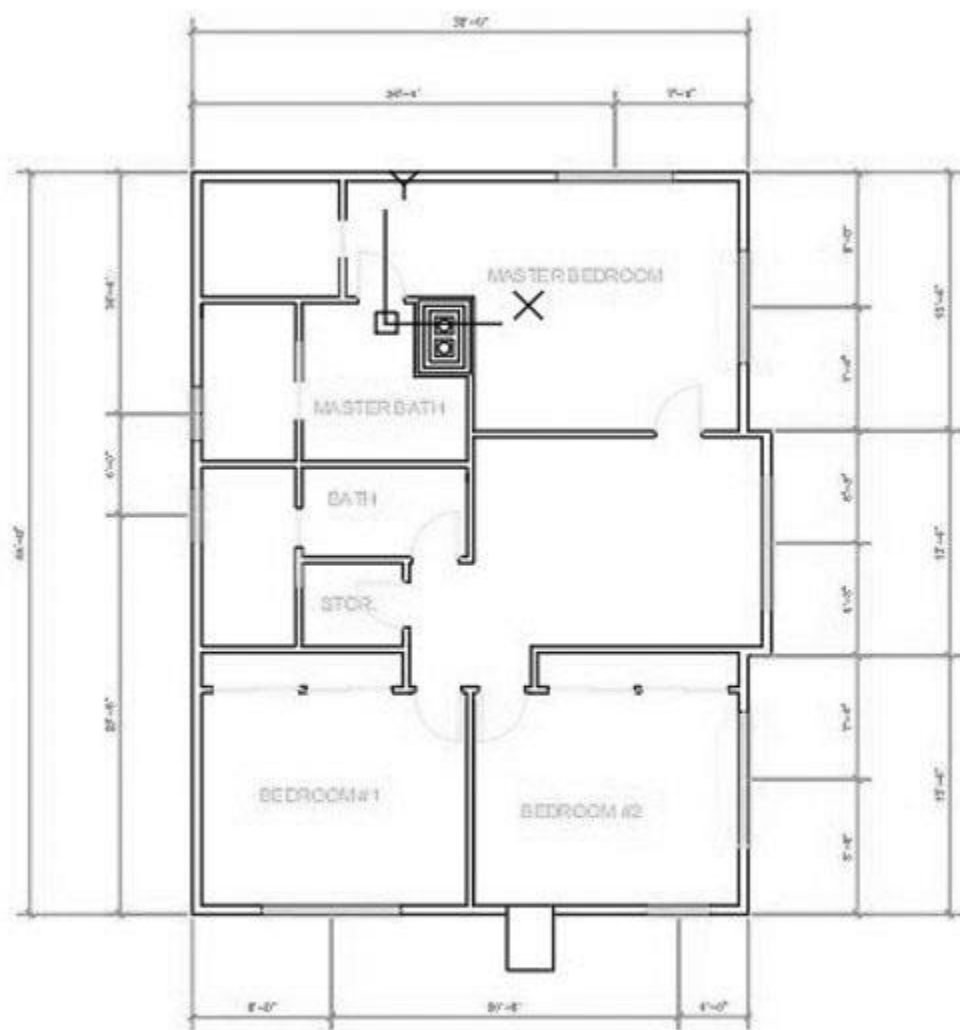

Navigation and view controls:

- Compass with N, S, E, W directions.
- View mode selector: TOP (selected).
- Zoom in (+) and zoom out (-) icons.
- Reset view icon.
- Label: Unnamed

Interaction toolbar:

- View mode icons: 2D Wireframe (selected), 3D, Top.
- Navigation icons: Pan, Rotate, Zoom.

File path: D:\Bldg\2024\1-10-24\lego_309

Title Block, 2 FLOOR

NAME: pourchista Shukh

CLASS ID: 150

DATE: 03/20/2024

SHEET NO:
A-2



TTitle Block, 1 FLOOR Interior

NAME: pourchista
Shahi

CLASS-ID: 160

DATE: 04/26/2024

SHEET NO.

ANSI-B

Floor 1 – FINAL

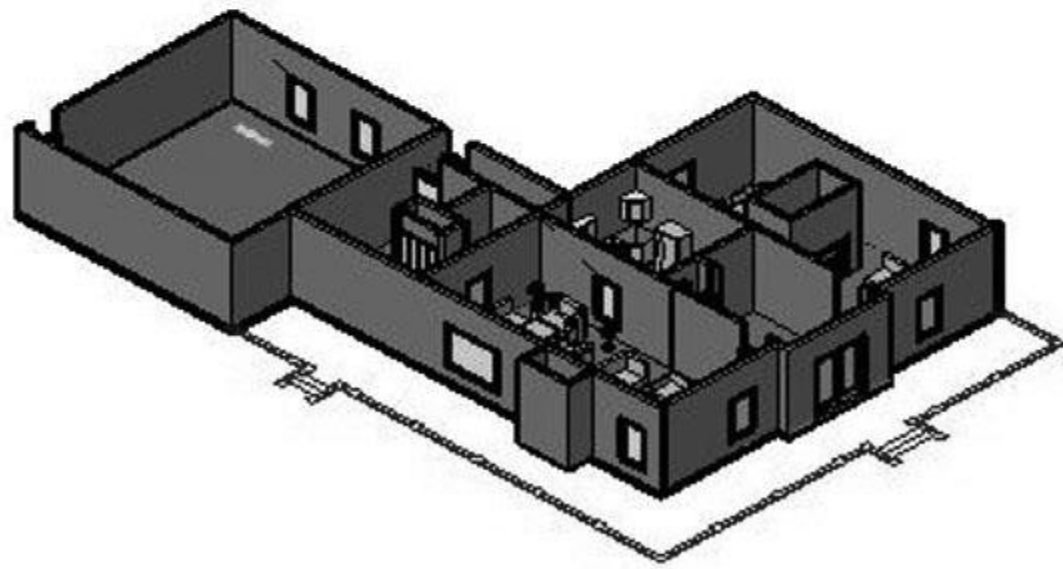

NAME : pour chate
State
CLASS ID 150
DATE : 05/22/2024

SHEET NO.
A-16

[+][Top][2D Wireframe]

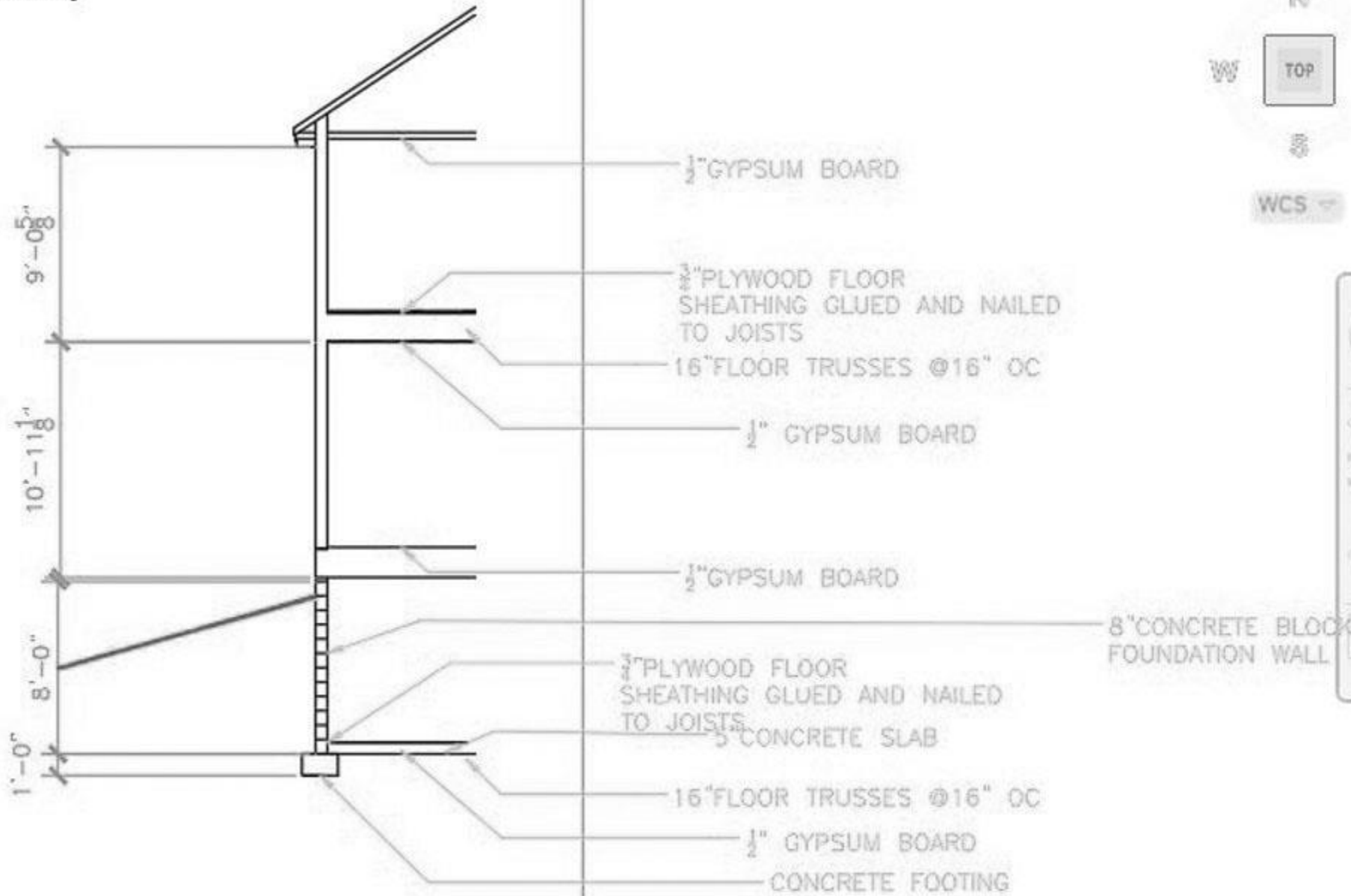

CH6 - WALL SECTION

NAME: Pouchista shah

CLASS: ID 150

DATE: 04/14/24

SHEET NO.

A-1

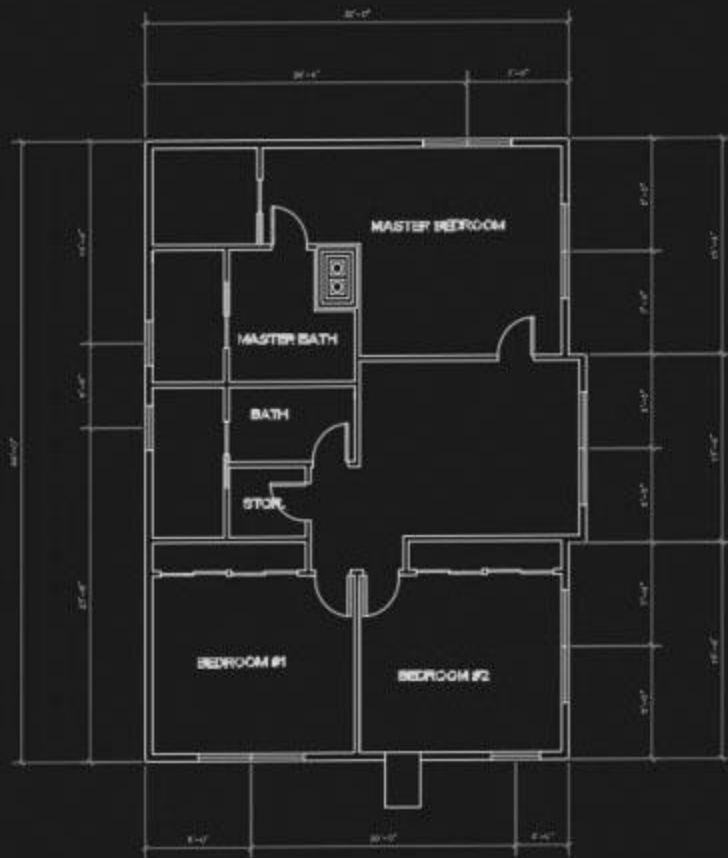

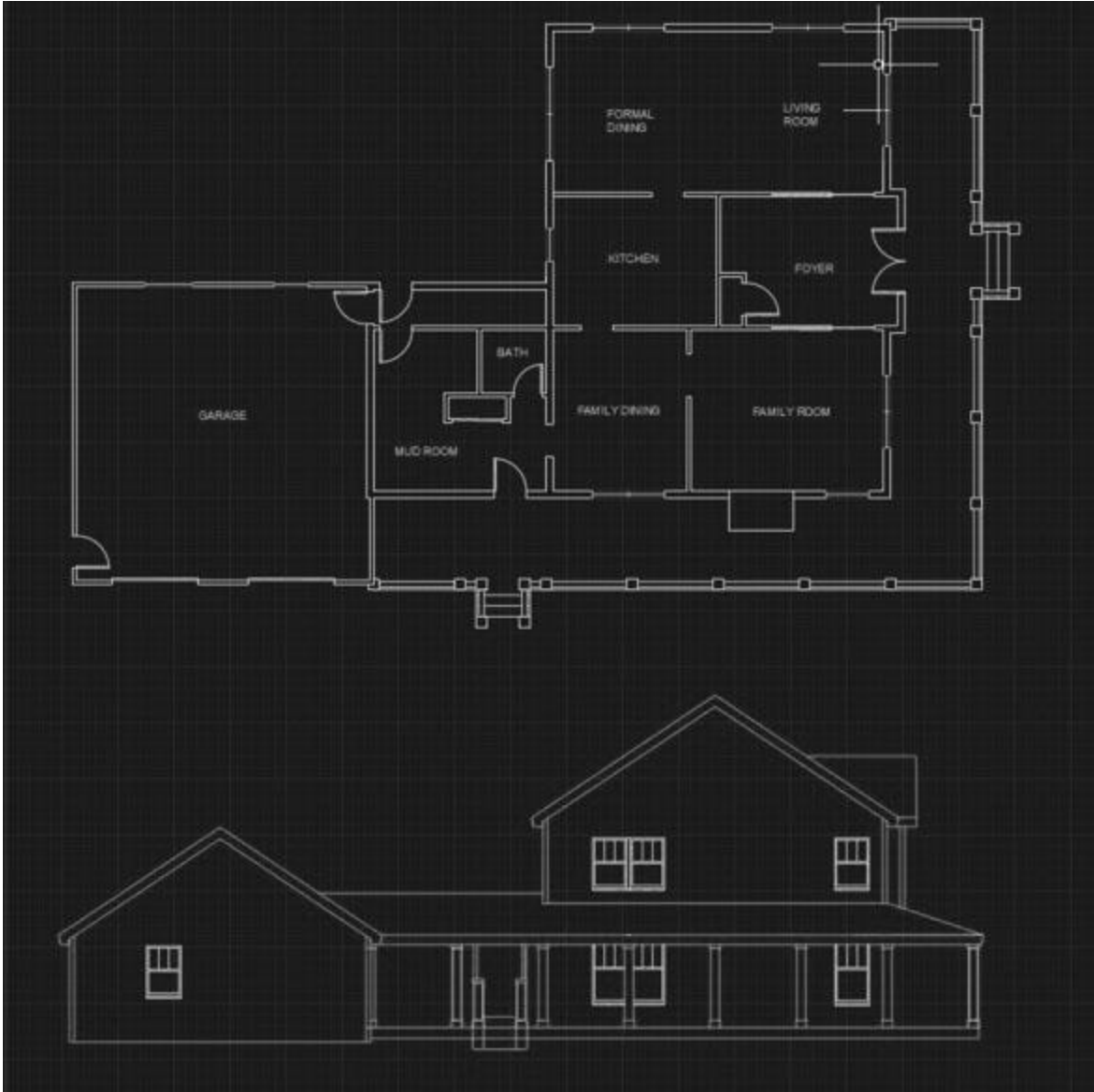

Design 2020 –
Kitchen & Bath



U-shape kitchen

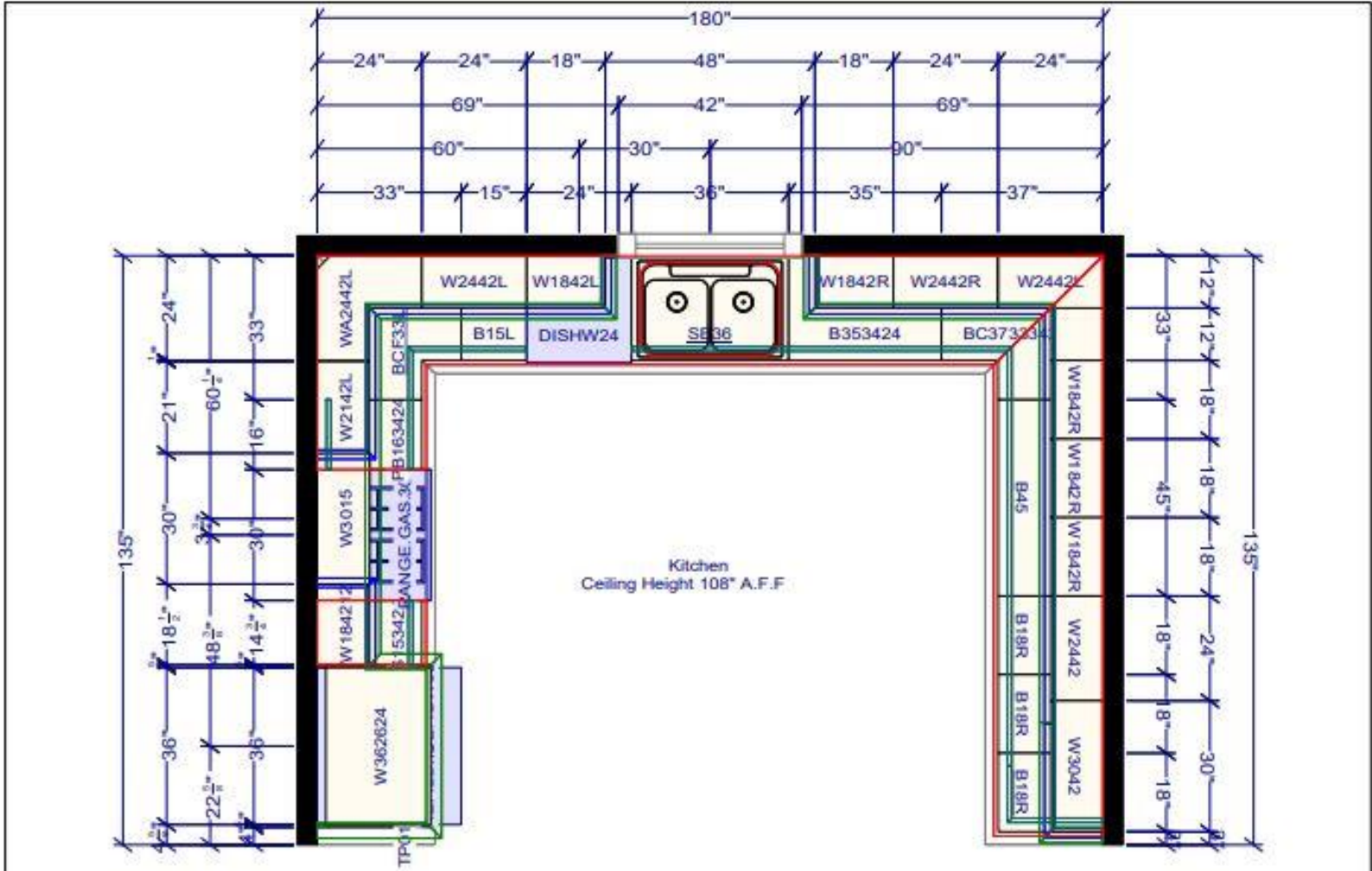

<p>All dimensions ,size designations given are subject to verification on job site and adjustment to fit job conditions.</p>	<p>Pourchista Shahi Project #1 u shape kitchen design Spring 2023 ID 145 Kitchen ,bath Design</p>	<p>This is an original design and must not be released or copied unless applicable fee has been paid or job order placed.</p>	<p>Designed: 10/3/2023 Printed: 10/5/2023</p>
<p>Design2-small unshape spring 2023-3</p>			<p>All Drawing #: 1 No Scale.</p>

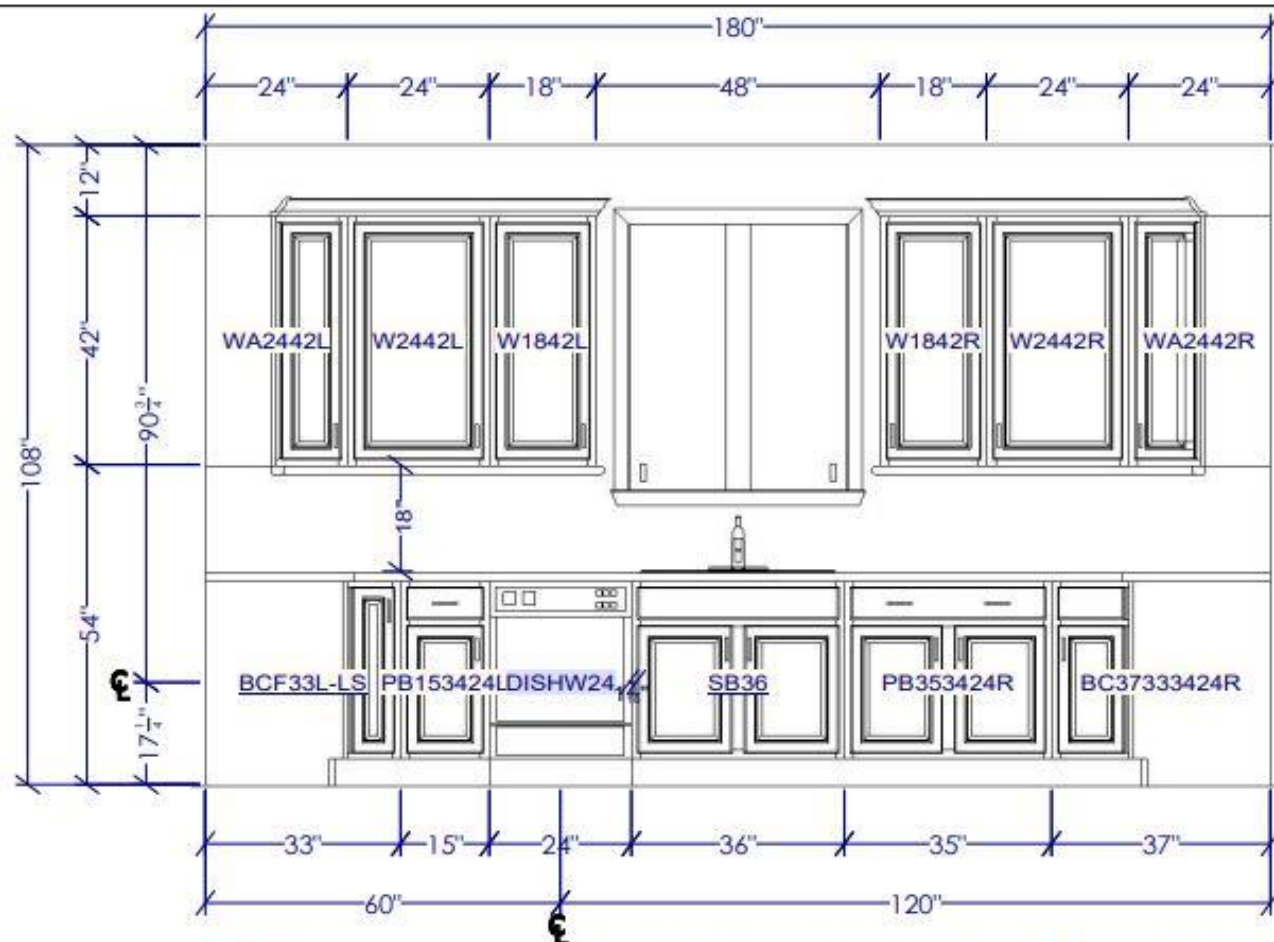

All dimensions, size designations given are subject to verification on job site and adjustment to fit job conditions.

Pourchista Shahi
Project #1
u shape kitchen design
Spring 2023 ID 145
Kitchen, bath Design

This is an original design and must not be released or copied unless applicable fee has been paid or job order placed.

Designed: 10/3/2023
Printed: 10/5/2023

Design2-small unshape spring 2023-3

Range wall Elevation Drawing #: 1 No Scale.

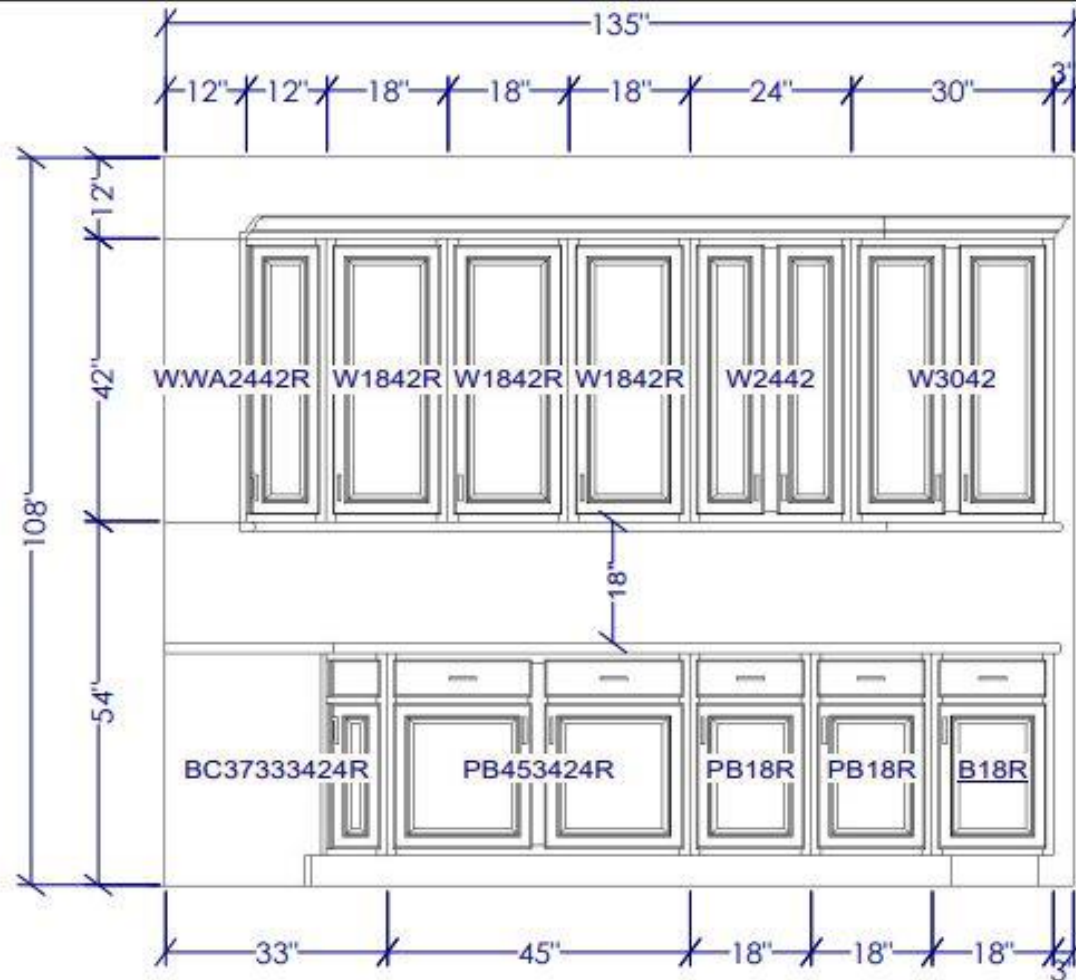

All dimensions ,size designations given are subject to verification on job site and adjustment to fit job conditions.

Pourchista Shahi
Project #1
u shape kitchen design
Spring 2023 ID 145
Kitchen ,bath Design

This is an original design and must not be released or copied unless applicable fee has been paid or job order placed.

Designed: 10/3/2023
Printed: 10/5/2023

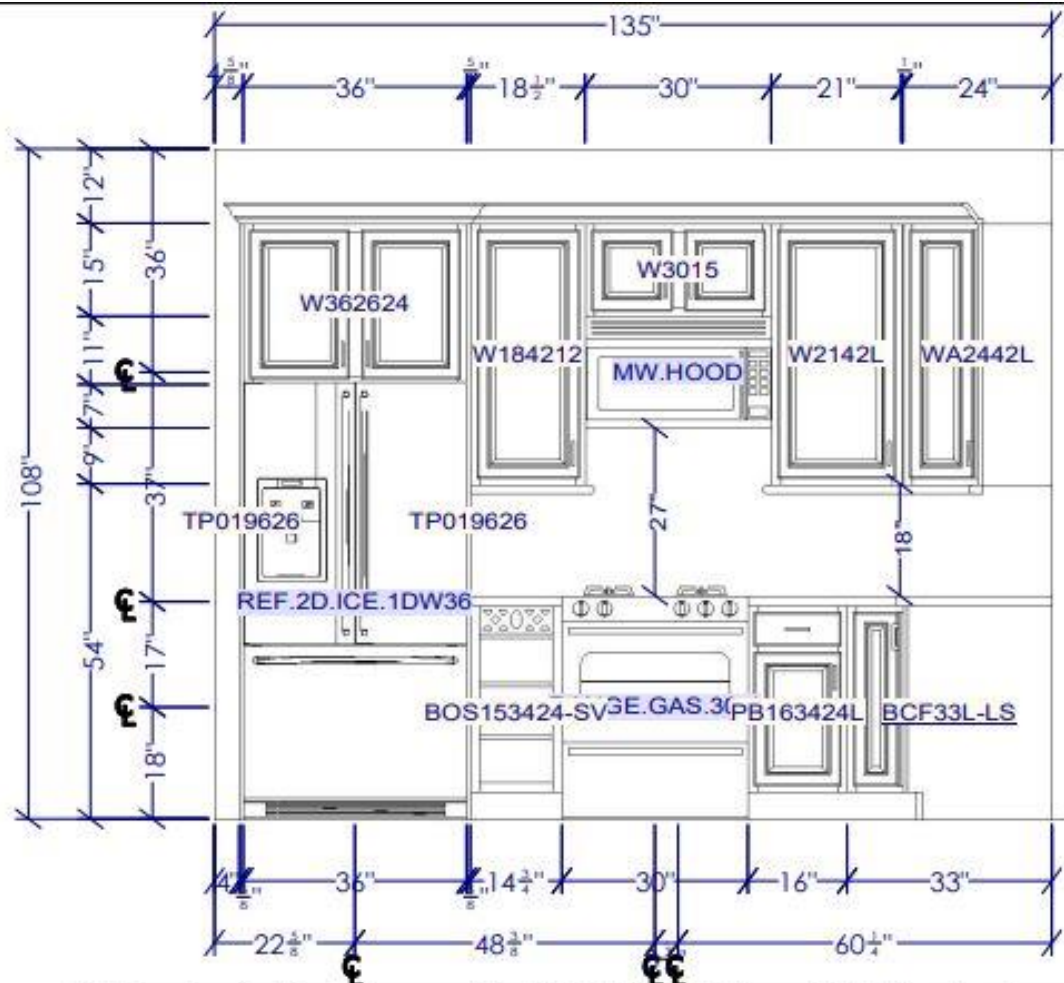

All dimensions ,size designations given are subject to verification on job site and adjustment to fit job conditions.

Pourchista Shahi
Project #1
u shape kitchen design
Spring 2023 ID 145
Kitchen ,bath Design

This is an original design and must not be released or copied unless applicable fee has been paid or job order placed.

Designed: 10/3/2023
Printed: 10/5/2023

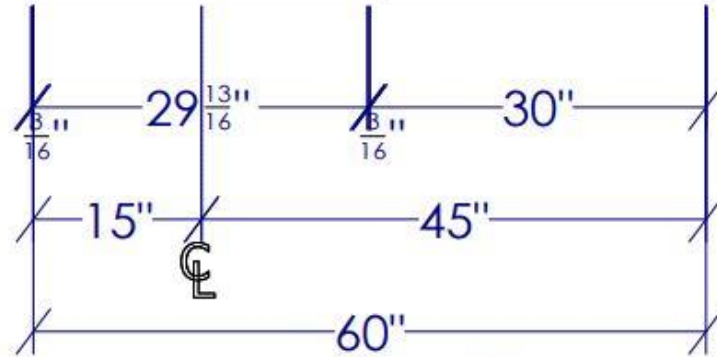
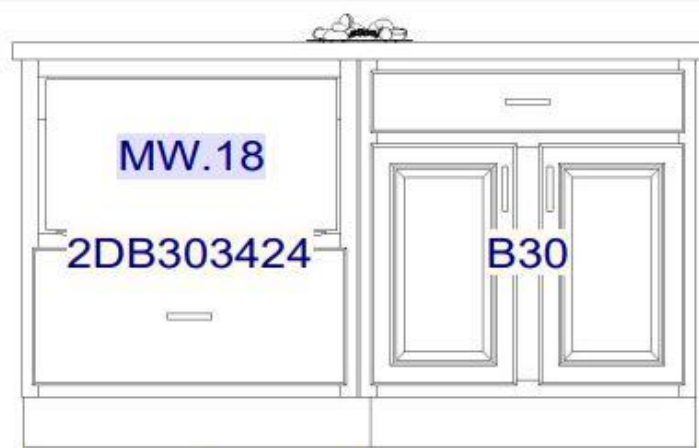

All dimensions, size designations given are subject to verification on job site and adjustment to fit job conditions.

Pourchista Shahi
Project #1
u shape kitchen design
Spring 2023 ID 145
Kitchen ,bath Design

This is an original design and must not be released or copied unless applicable fee has been paid or job order placed.

Designed: 10/23/2023
Printed: 10/24/2023

project 2 23

peninsula elevation Drawing #: 1 No Scale.

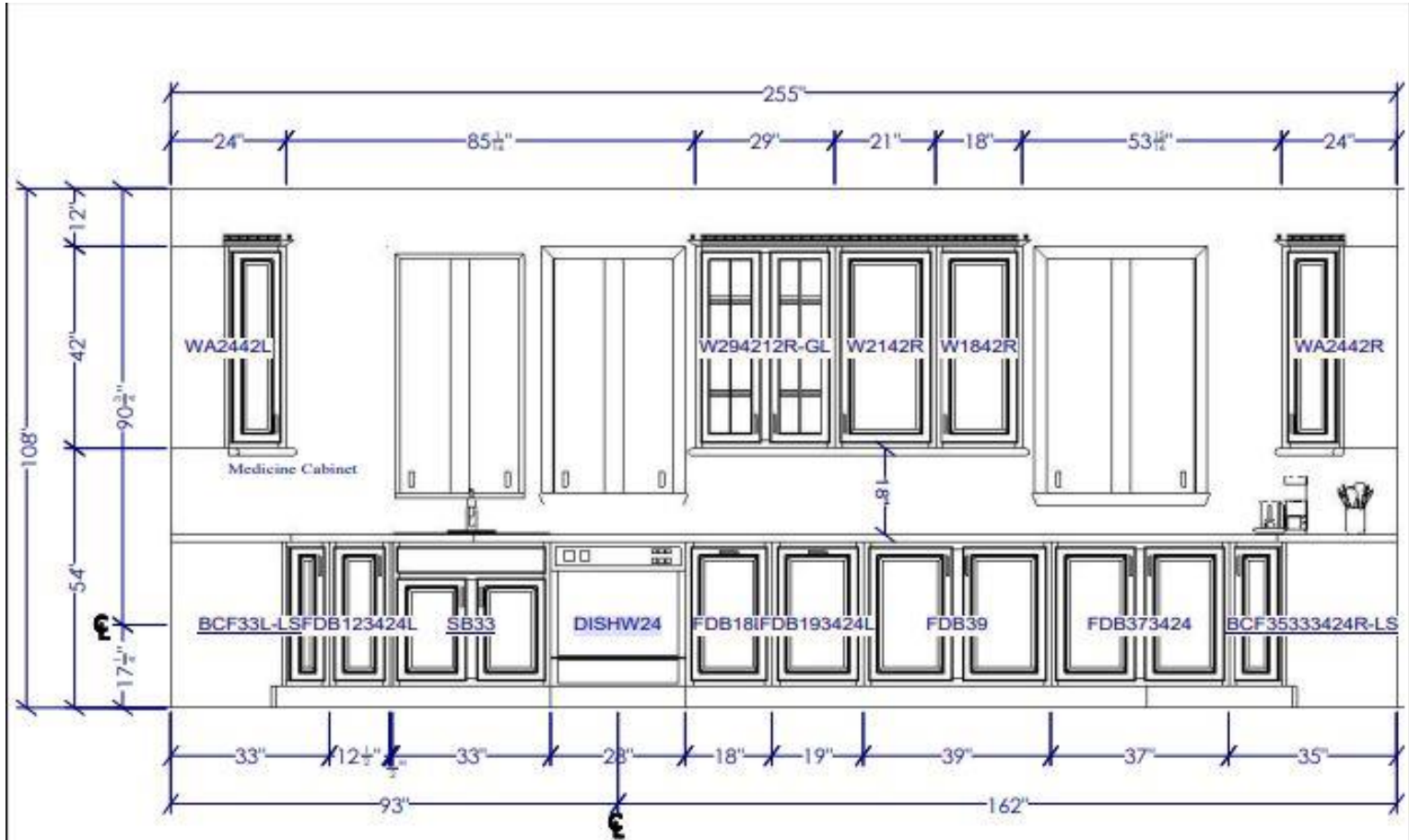

All dimensions ,size designations given are subject to verification on job site and adjustment to fit job conditions.

Pourchista Shahi
Project #1
u shape kitchen design
Spring 2023 ID 145
Kitchen ,bath Design

This is an original design and must not be released or copied unless applicable fee has been paid or job order placed.

Designed: 10/23/2023
Printed: 10/24/2023

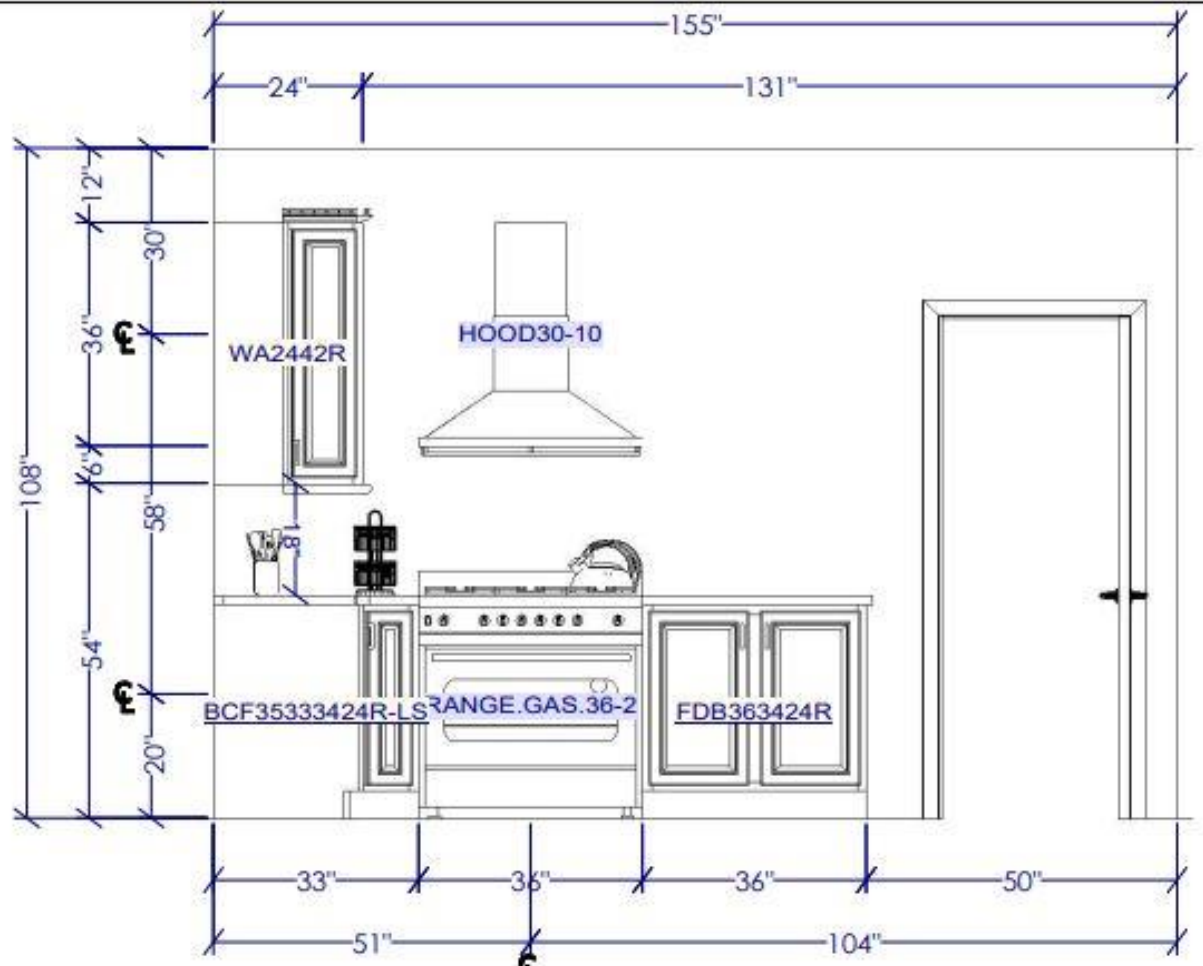

All dimensions & size designations given are subject to verification on job site and adjustment to fit job conditions.	Pourchista Shahi Project #1 u shape kitchen design Spring 2023 ID 145 Kitchen & bath Design	This is an original design and must not be released or copied unless applicable fee has been paid or job order placed.	Designed: 10/23/2023 Printed: 10/24/2023
	project 2 23	side yard elevation	Drawing #: 1 No Scale.

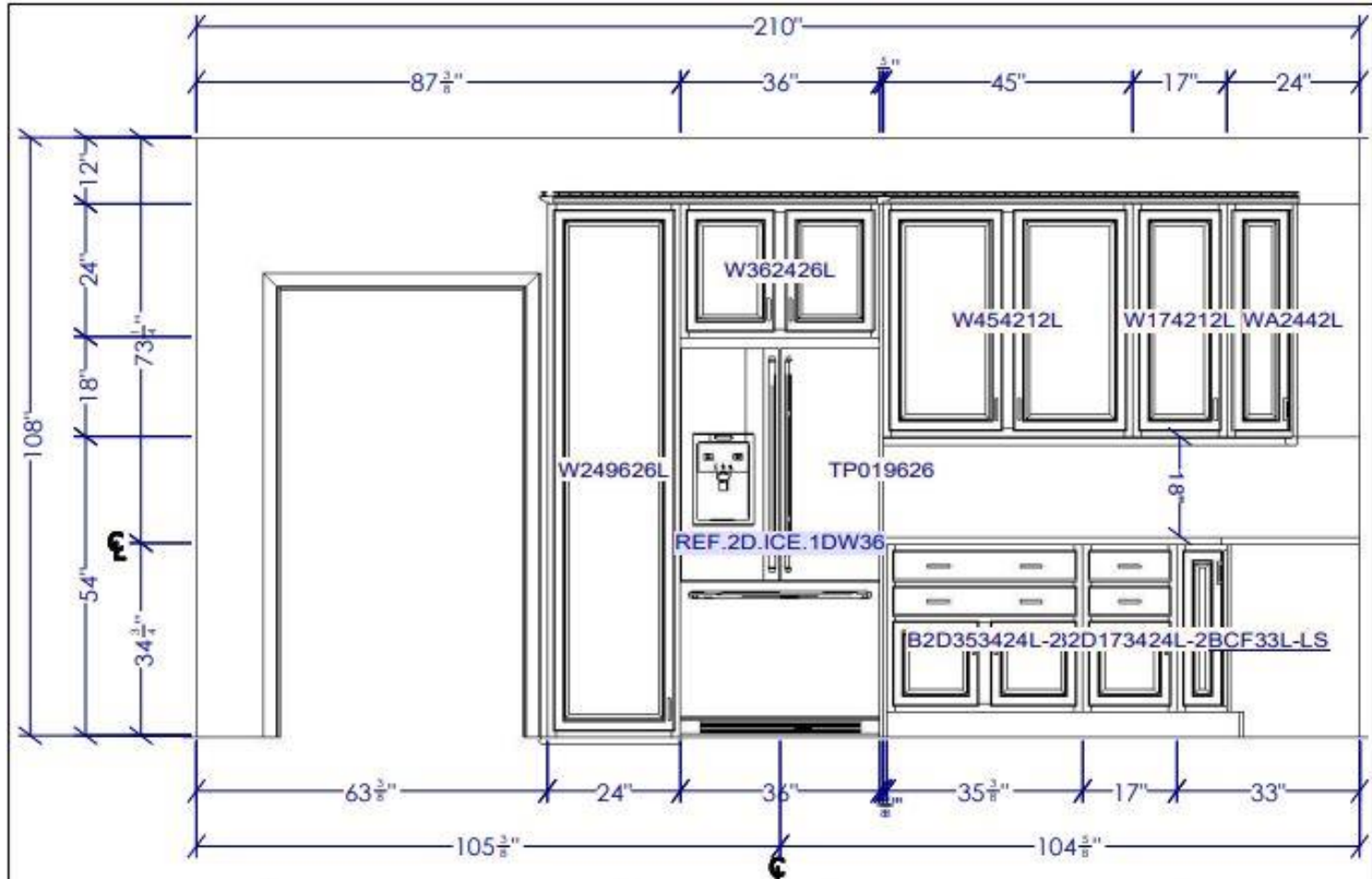

<p>All dimensions ,size designations given are subject to verification on job site and adjustment to fit job conditions.</p>	<p>Pourchista Shahi Project #1 u shape kitchen design Spring 2023 ID 145 Kitchen ,bath Design</p>	<p>This is an original design and must not be released or copied unless applicable fee has been paid or job order placed.</p>	<p>Designed: 10/23/2023 Printed: 10/24/2023</p>
<p>project 2 23</p>	<p>refrigerator</p>	<p>Drawing #: 1</p>	<p>No Scale.</p>

Shower Elevation

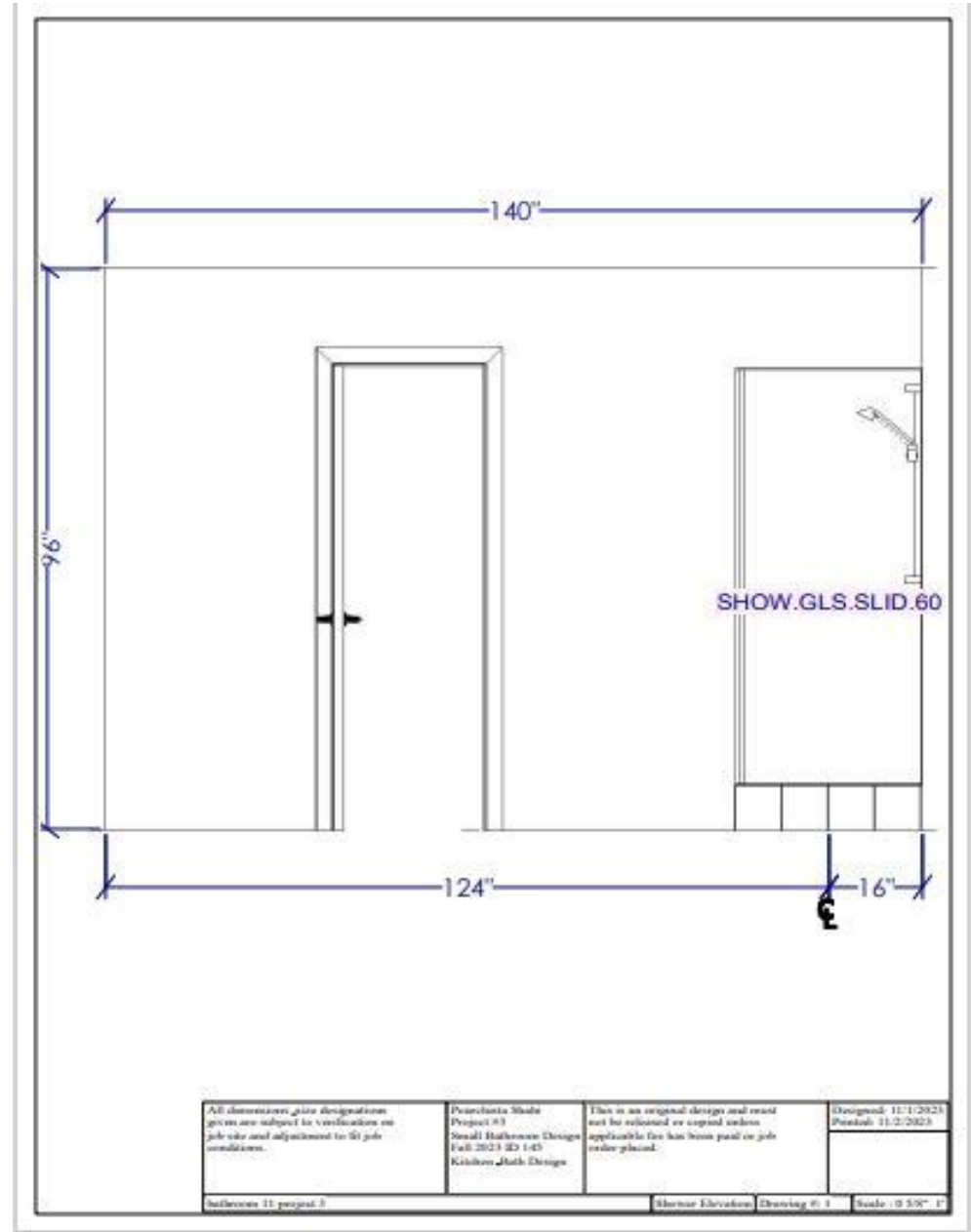

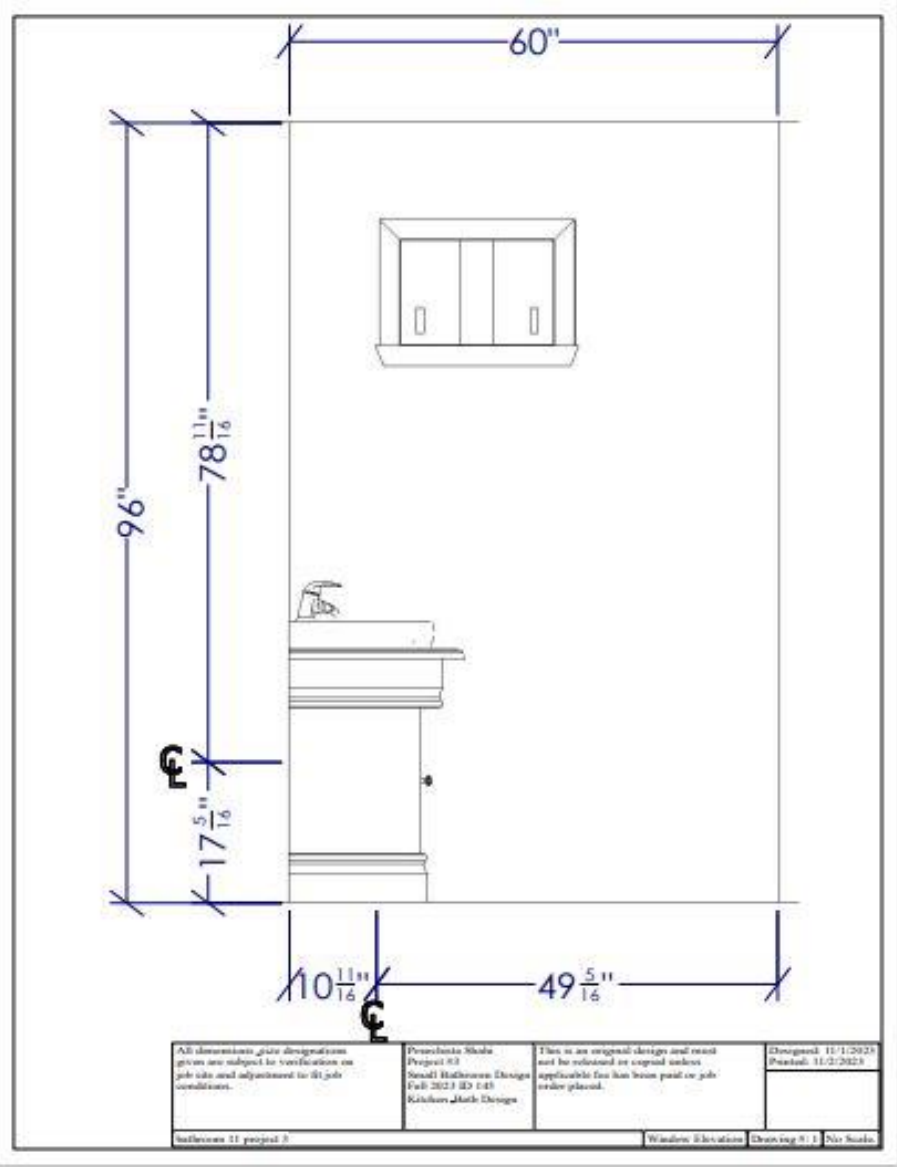

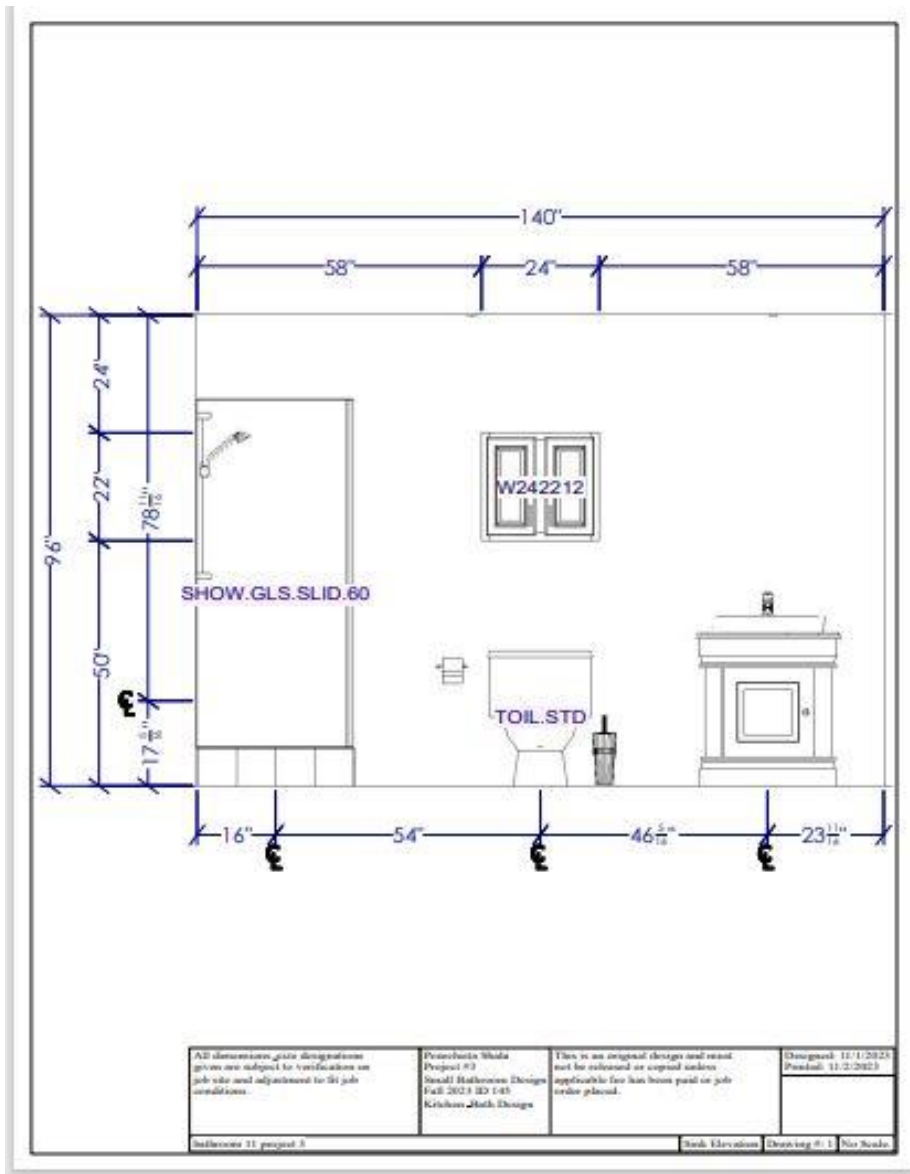

All dimensions, gate designations given are subject to verification on job site and adjustment to fit job conditions.	Powerbark Works Project #3 Small Bathroom Design Fall 2023 ID 143 Kricker Bath Design	This is an original design and must not be released or copied unless applicable fee has been paid to job order placed.	Designed: 11/1/2023
			Printed: 11/2/2023
Bathroom 11 project 3			Stall Elevation Drawing # 1 No Notes

Sink Elevation

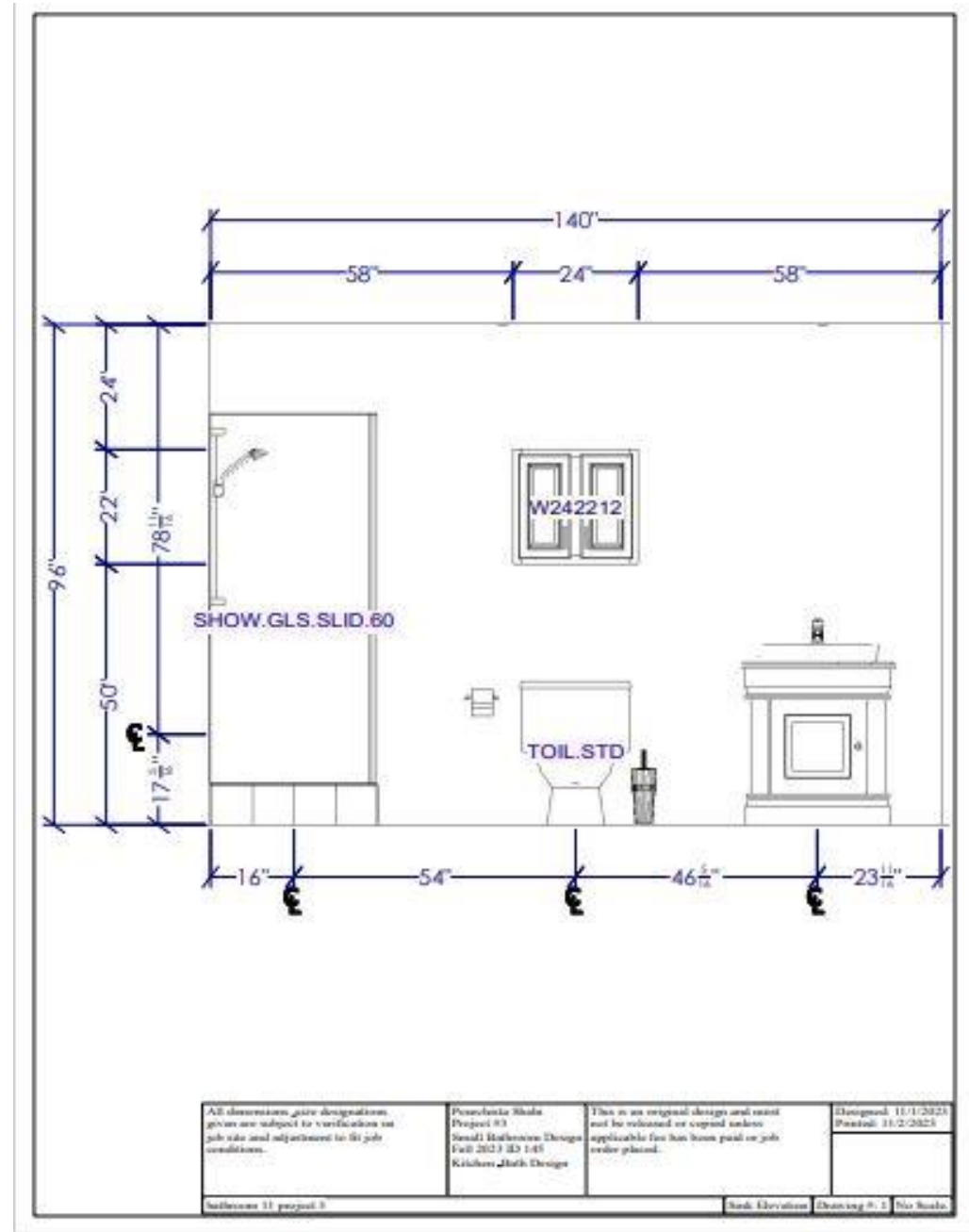

Window Elevation

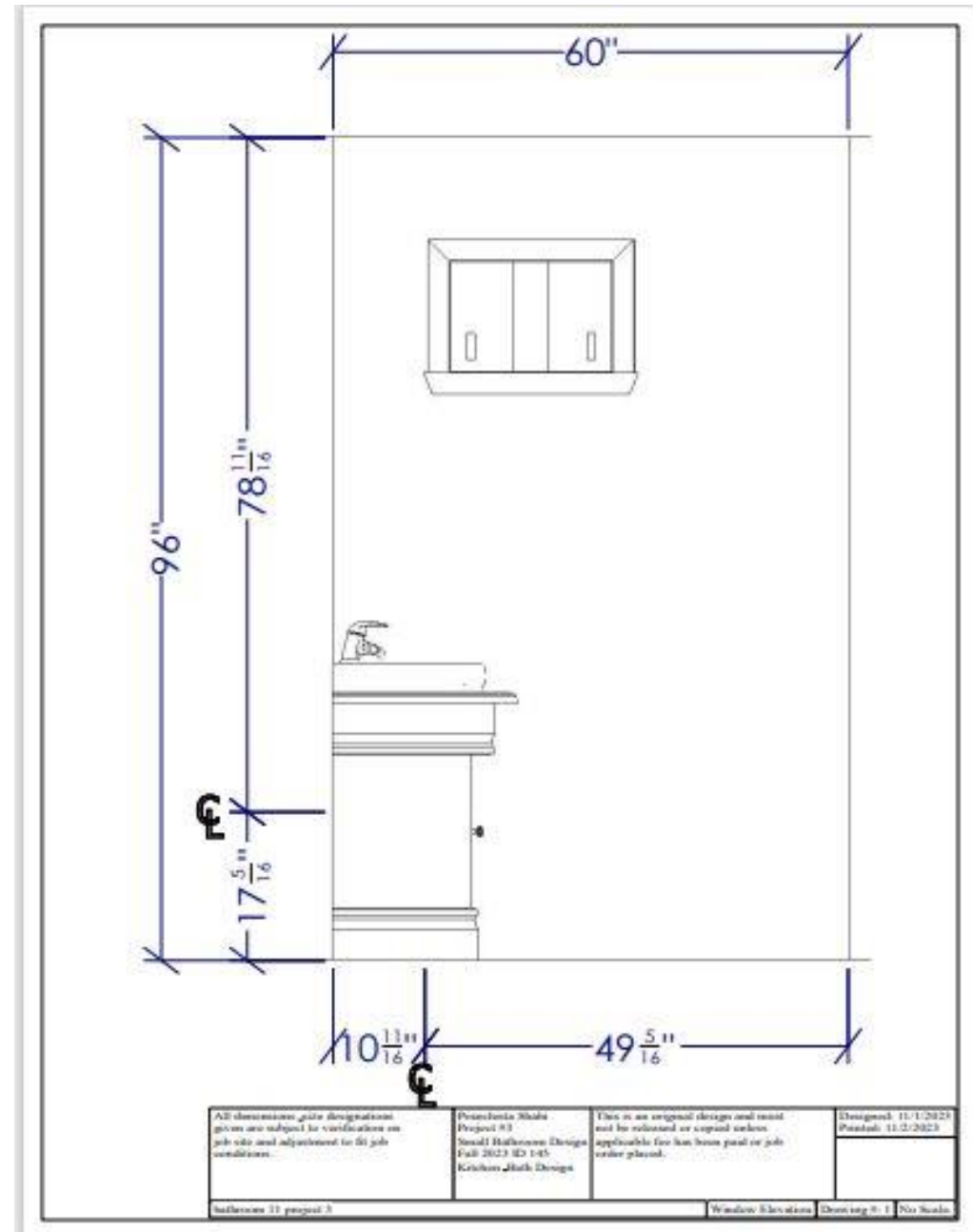

Work Area

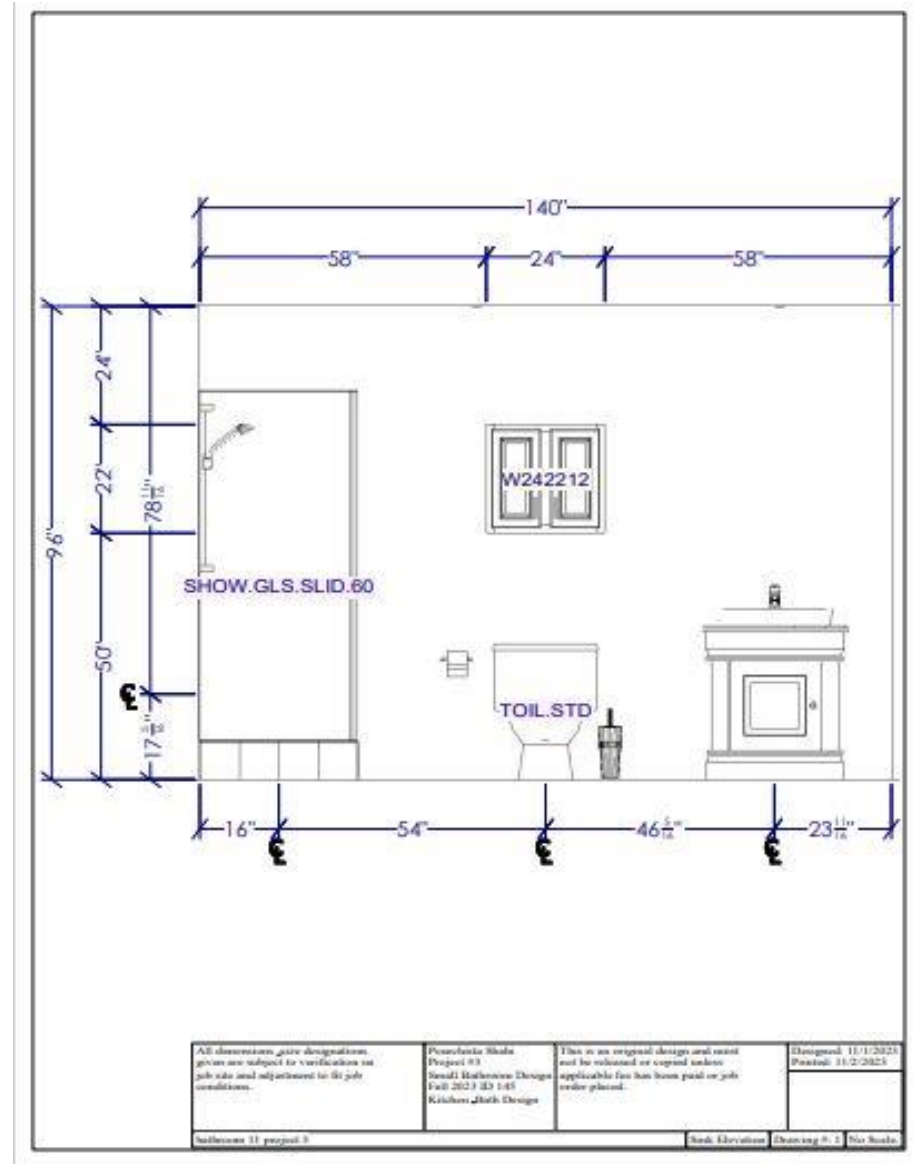

Large kitchen Elevation with Back yard Door

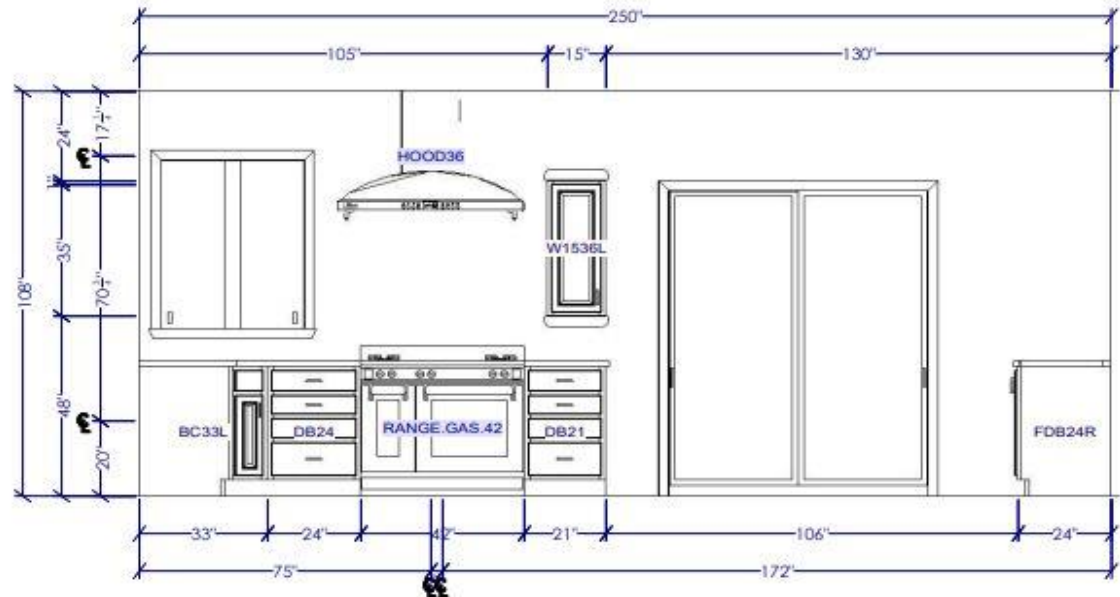

<p>All dimensions _size designations given are subject to verification on job site and adjustment to fit job conditions.</p>	<p>Pourchista Shahi Project#4 Large Kitchen Design Fall 2023 ID 145 Kitchen_Bath Design</p>	<p>This is an original design and must not be released or copied unless applicable fee has been paid or job order placed.</p>	<p>Designed: 11/29/2023 Printed: 12/12/2023</p>	
<p>kitchen design 4 wednesday 29</p>		<p>Back Yard</p>	<p>Drawing #: 1</p>	<p>Scale : 0 1/2" 1'</p>

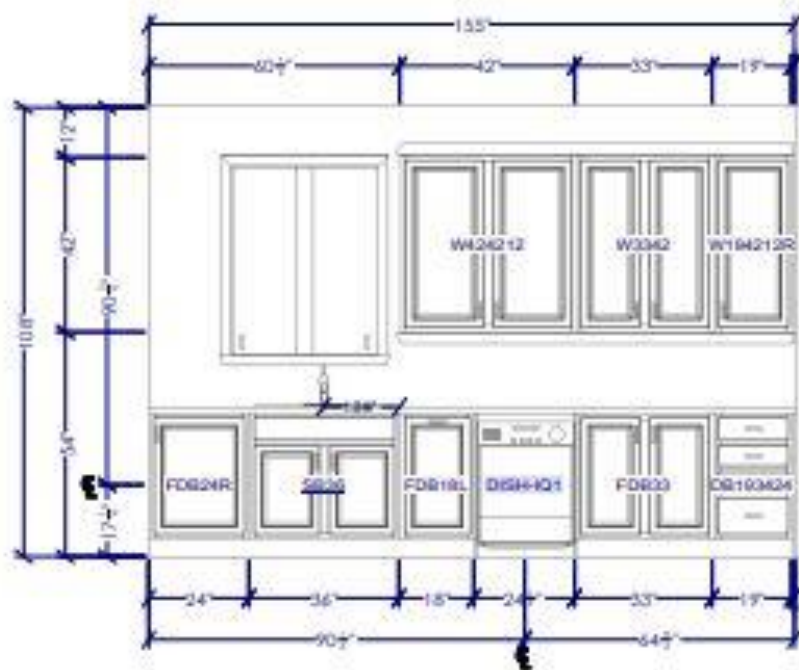

<p>All dimensions, size designations given are subject to verification on job site and adjustment to fit job conditions.</p>	<p>Pourchiata Shaha Project#4 Large Kitchen Design Fall 2023 ID 145 Kitchen_Bath Design</p>	<p>This is an original design and must not be released or copied unless applicable fee has been paid or job order placed.</p>	<p>Designed: 11/29/2023 Printed: 12/12/2023</p>
--	---	---	---

Refrigerator and pantry elevation

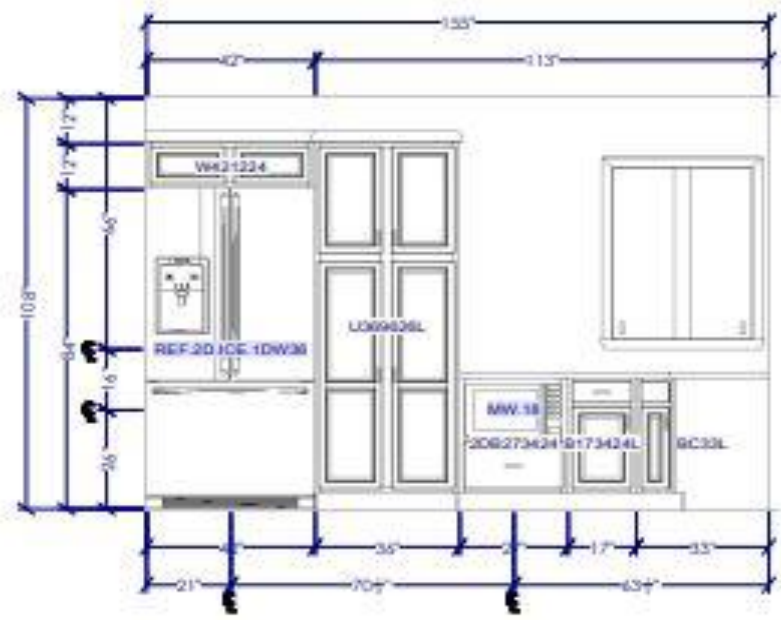

<p>All dimensions, size designations given are subject to verification on job site and adjustment to fit job conditions.</p>	<p>Pourchista Shahi Project#4 Large Kitchen Design Fall 2023 ID 145 Kitchen_Bath Design</p>	<p>This is an original design and must not be released or copied unless applicable fee has been paid or job order placed.</p>	<p>Designed: 11/29/2023 Printed: 12/12/2023</p>
<p>kitchen design 4 wednesday 29</p>		<p>Side Yard left</p>	<p>Drawing #: 1 Scale : 0 1/2" = 1'</p>

Top Cabinet

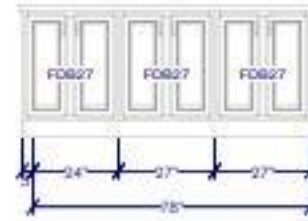

All dimensions & size designations given are subject to verification on job site and adjustment to fit job conditions.	Pouchista Shahi Project#4 Large Kitchen Design Fall 2023 ID 145 Kitchen_Bath Design	This is an original design and must not be released or copied unless applicable fee has been paid or job order placed.	Designed: 11/29/2023
			Printed: 12/12/2023
kitchen design 4 wednesday 29	Island	Drawing #: 1	Scale : 0 1/2" = 1'

Kitchen Material



Revit

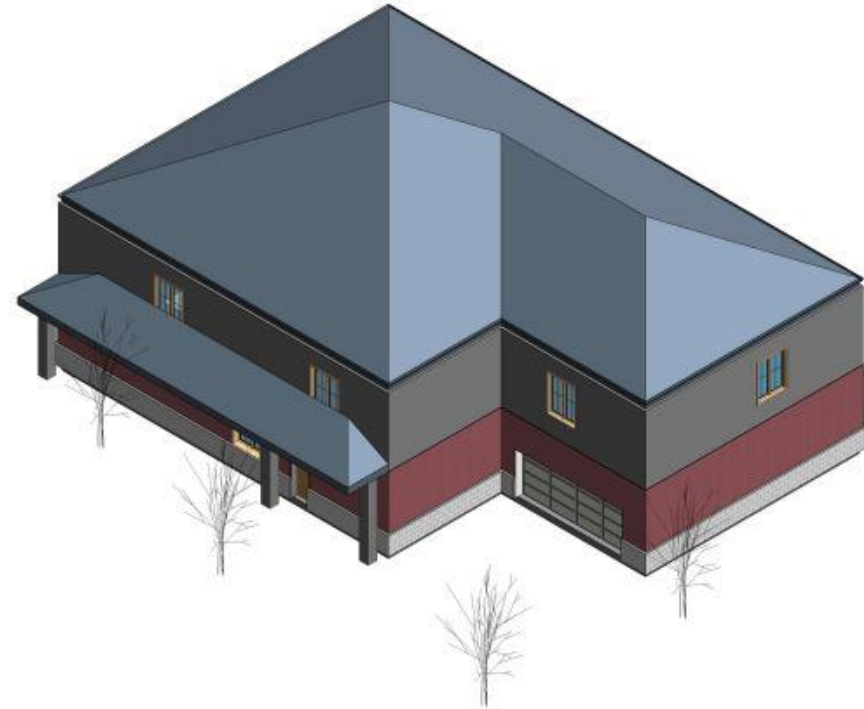

① (3D)



Palomar College
Drafting Technology Program
College in San Marcos, California
1140 W Mission Rd, San Marcos, CA 92069

3Dview

Project Name: Intro to revit

Class Info:

Original Layout: 11" x 11"
Scale:

Designer: pourchista
Shahi

A108

Door Schedule			
Count	Width	Height	Type
1	3' - 0"	7' - 0"	36" x 84"
1	2' - 6"	7' - 0"	30" x 84"
1	18' - 0"	7' - 0"	garage door large
1	2' - 6"	7' - 0"	30" x 84"
1	2' - 6"	7' - 0"	30" x 84"
1	2' - 6"	7' - 0"	30" x 84"
1	2' - 8"	7' - 0"	32" x 84"
1	2' - 8"	7' - 0"	32" x 84"

Window Schedule			
Height	Type	Width	Count
6' - 0"	57" x 72"	4' - 9"	1
6' - 0"	57" x 72"	4' - 9"	1
6' - 0"	57" x 72"	4' - 9"	1
6' - 0"	57" x 72"	4' - 9"	1
6' - 0"	57" x 72"	4' - 9"	1
6' - 0"	57" x 72"	4' - 9"	1
6' - 0"	57" x 72"	4' - 9"	1
6' - 0"	57" x 72"	4' - 9"	1
6' - 0"	57" x 72"	4' - 9"	1
6' - 0"	57" x 72"	4' - 9"	1



① 3D View 2



Floor Plan 1,2

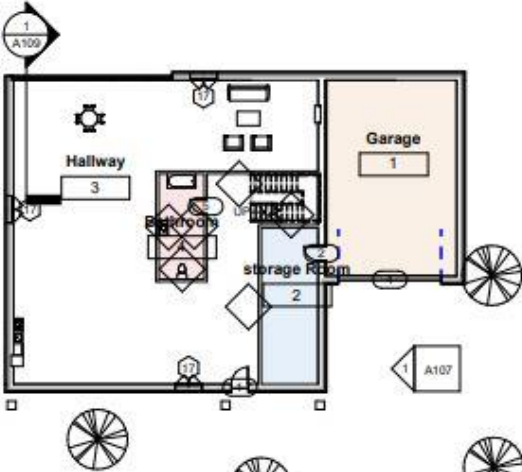

- ① Level 1
1/16" = 1'-0"
- Room Legend**
- Bathroom
 - Garage
 - Hallway
 - storage Room

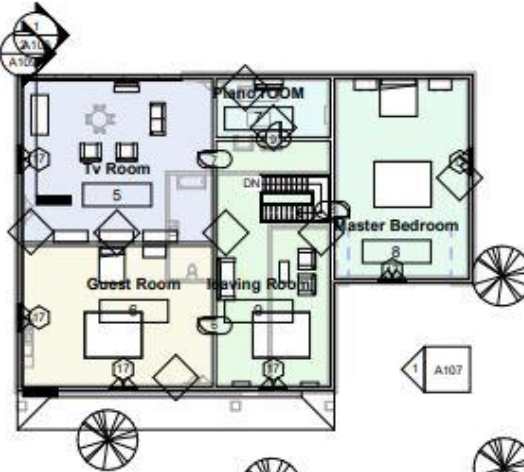

- ② Level 2
1/16" = 1'-0"
- Room Legend**
- Guest Room
 - leaving Room
 - Master Bedroom
 - Piano rOOM
 - Tv Room

Roof Plan -Site

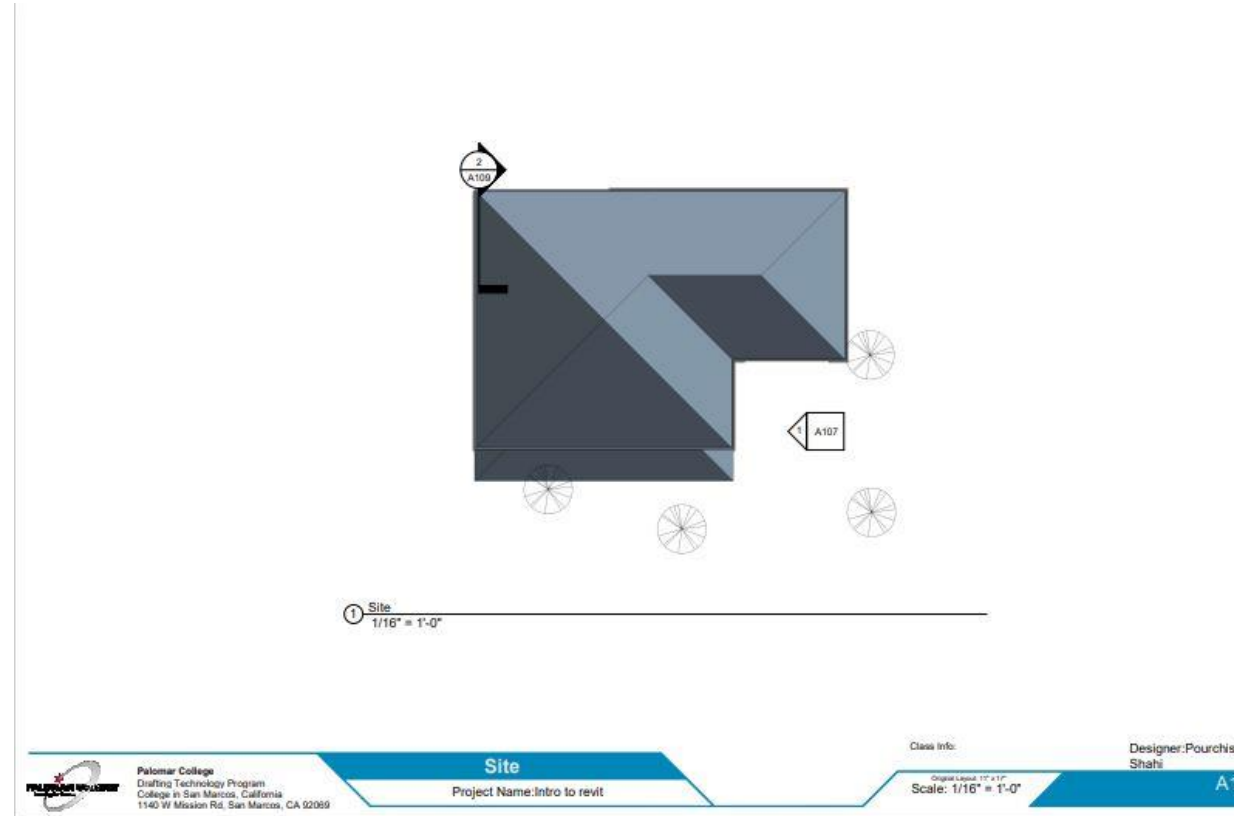
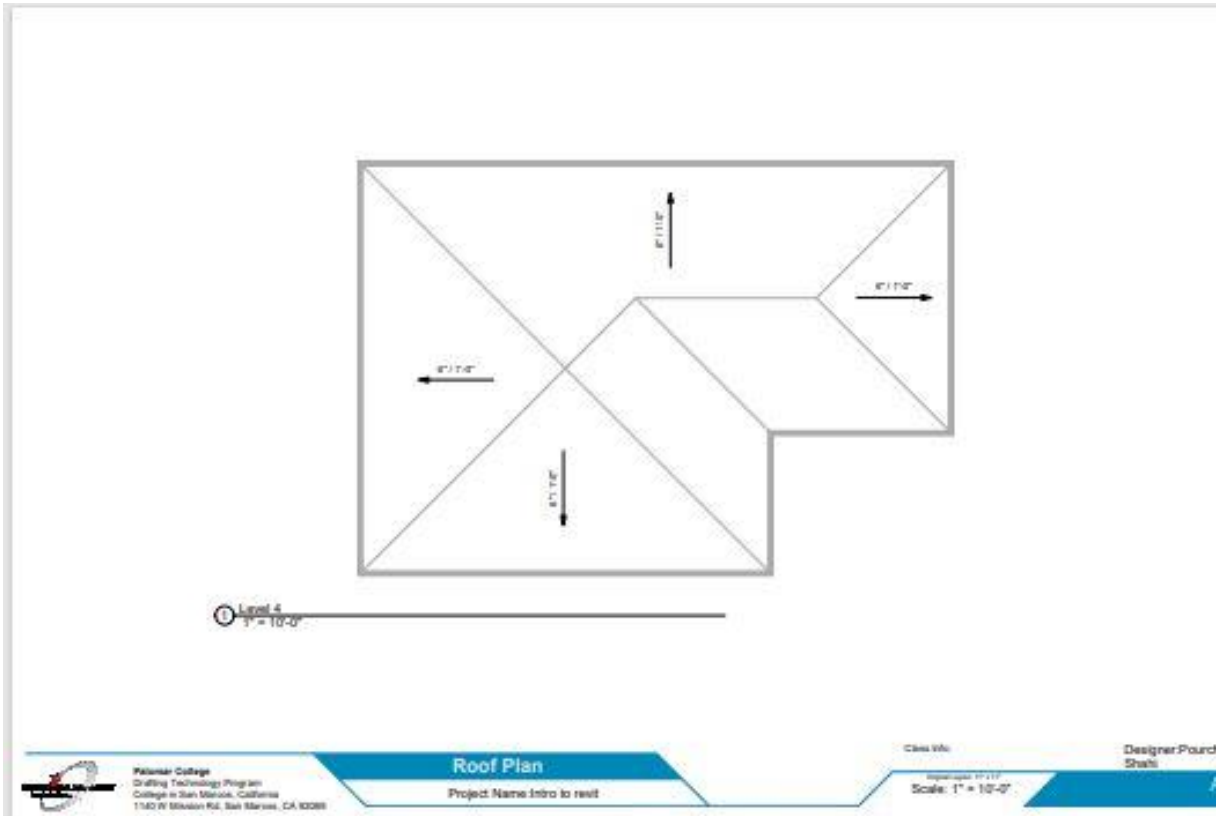

Reflection Plan

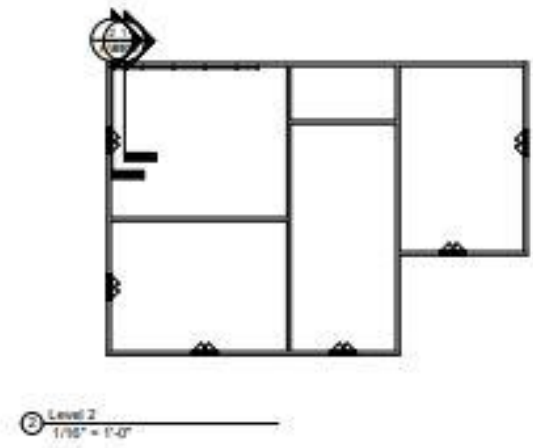
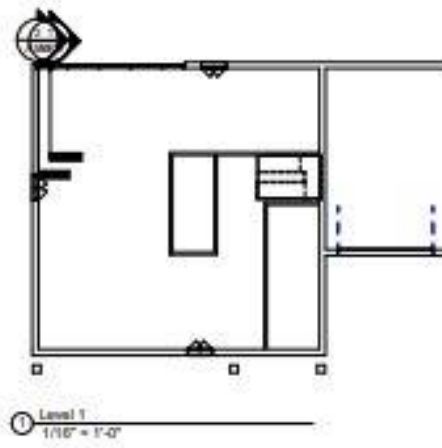

Palomar College
Drafting Technology Program
College of San Marcos, California
1180 W Mission Rd, San Marcos, CA 92069

Reflected ceiling

Project Name: Intro to revit

Class Info:

Project: Intro to Revit
Scale: 1/16" = 1'-0"

Designer: panchista
Shah

A104

Elevation East, west, north ,south

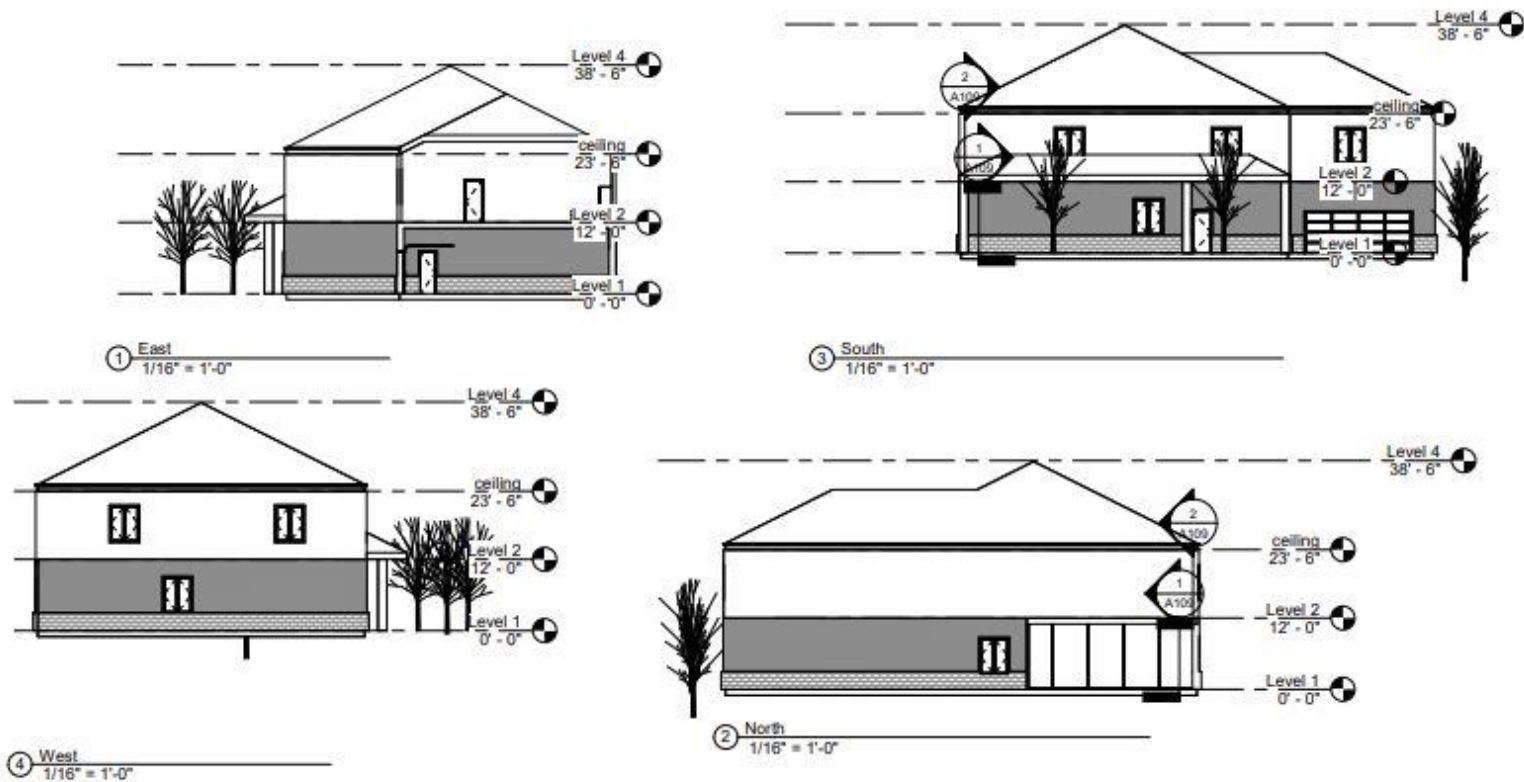

Palomar College
Drafting Technology Program
College in San Marcos, California
1140 W Mission Rd, San Marcos, CA 92069

Elevation East, west, north, south

Project Name: Intro to revit

Class Info:

Original Layout: 17' x 17'
Scale: 1/16" = 1'-0"

Designer: pourchista
Shahi

A107

Area Plan

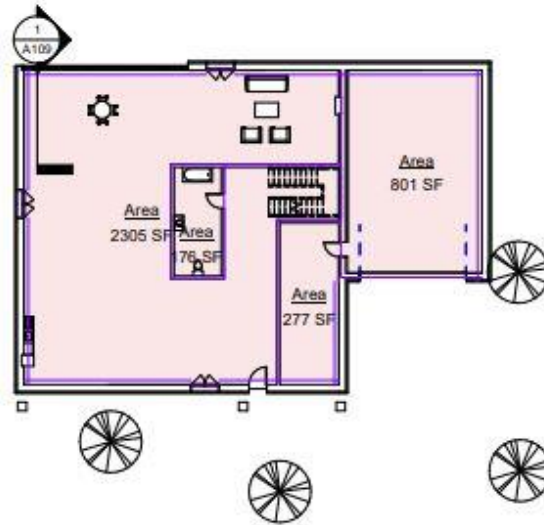

① Level 1
1/16" = 1'-0"

Rentable Area Legend

■ Building Common Area

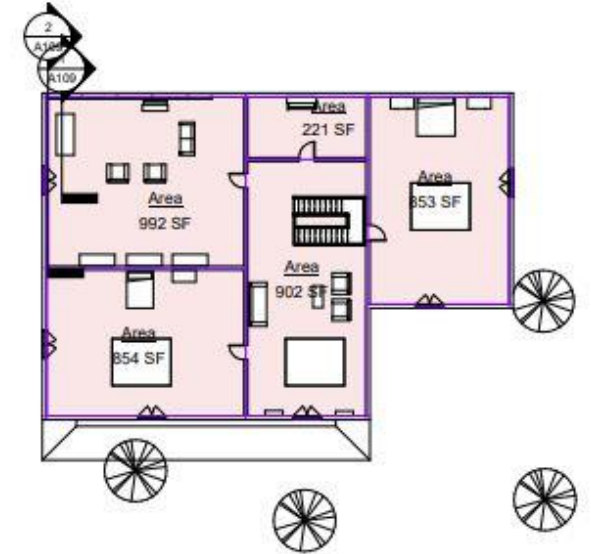

② Level 2
1/16" = 1'-0"

Rentable Area Legend

■ Building Common Area



Interior elevation

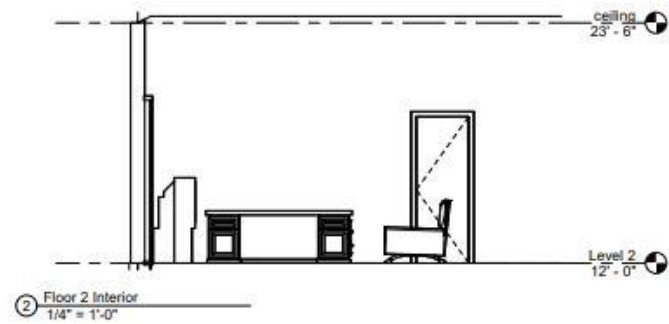
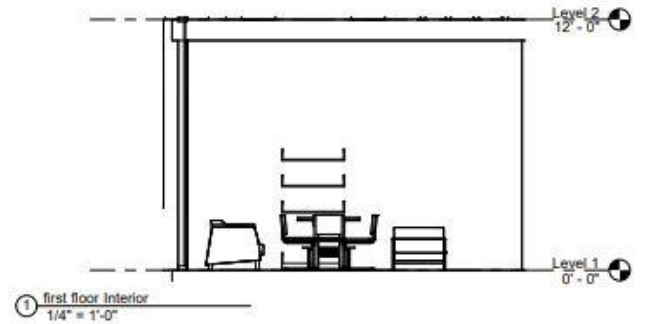

Palomar College
Drafting Technology Program
College in San Marcos, California
1140 W Mission Rd, San Marcos, CA 92069

Interior Elevation

Project Name: Intro to revit

Class Info:

Original Layout: 11" x 11"
Scale: 1/4" = 1'-0"

Designer: pourchista
Shahi

A109

Interior Render

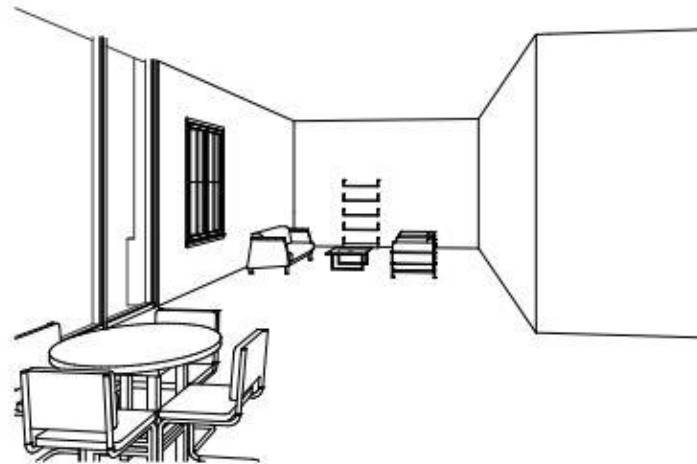

① 3D View 5



Palomar College
Drafting Technology Program
College of San Marcos, California
1140 W Mission Rd, San Marcos, CA 92069

Interior Render

Project Name: Intro to revit

Class Info:

Original Layout: 11" x 17"
Scale:

Designer: pourchista
Shahi

A110

3D Section View

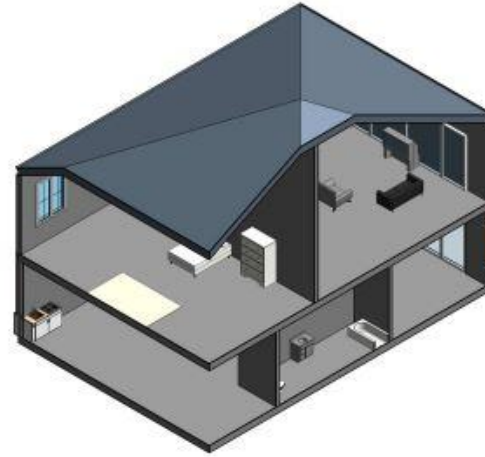

1 [3D] Copy 1



Palomar College
Drafting Technology Program
College in San Marcos, California
1140 W Mission Rd, San Marcos, CA 92069

3D Section View

Project Name: Intro to revit

Class Info:

Original Layout: 11" x 11"
Scale:

Designer: Pourchista shahi

A111

Sections

Section 1
 $3/32" = 1'-0"$

Level 4
 $38' - 6"$

ceiling
 $23' - 6"$

Level 2
 $12' - 0"$

Level 1
 $0' - 0"$

Section 3
 $3/32" = 1'-0"$

Level 4
 $38' - 6"$

ceiling
 $23' - 6"$

Level 2
 $12' - 0"$

Level 1
 $0' - 0"$

Section 1 - Callout 1
 $3/16" = 1'-0"$

ceiling
 $23' - 6"$

Level 2
 $12' - 0"$

Level 1
 $0' - 0"$

Section 3 - Callout 1
 $3/16" = 1'-0"$

Sections
 Project Name: Intro to revit

Palomar College
 Drafting Technology Program
 College in San Marcos, California
 1140 W Mission Rd, San Marcos, CA 92069

Class Info:
 Scale: As indicated

Designer: pourchista
 Shahi

Original Layout: 11" x 17"
 A112

Commercial
Project









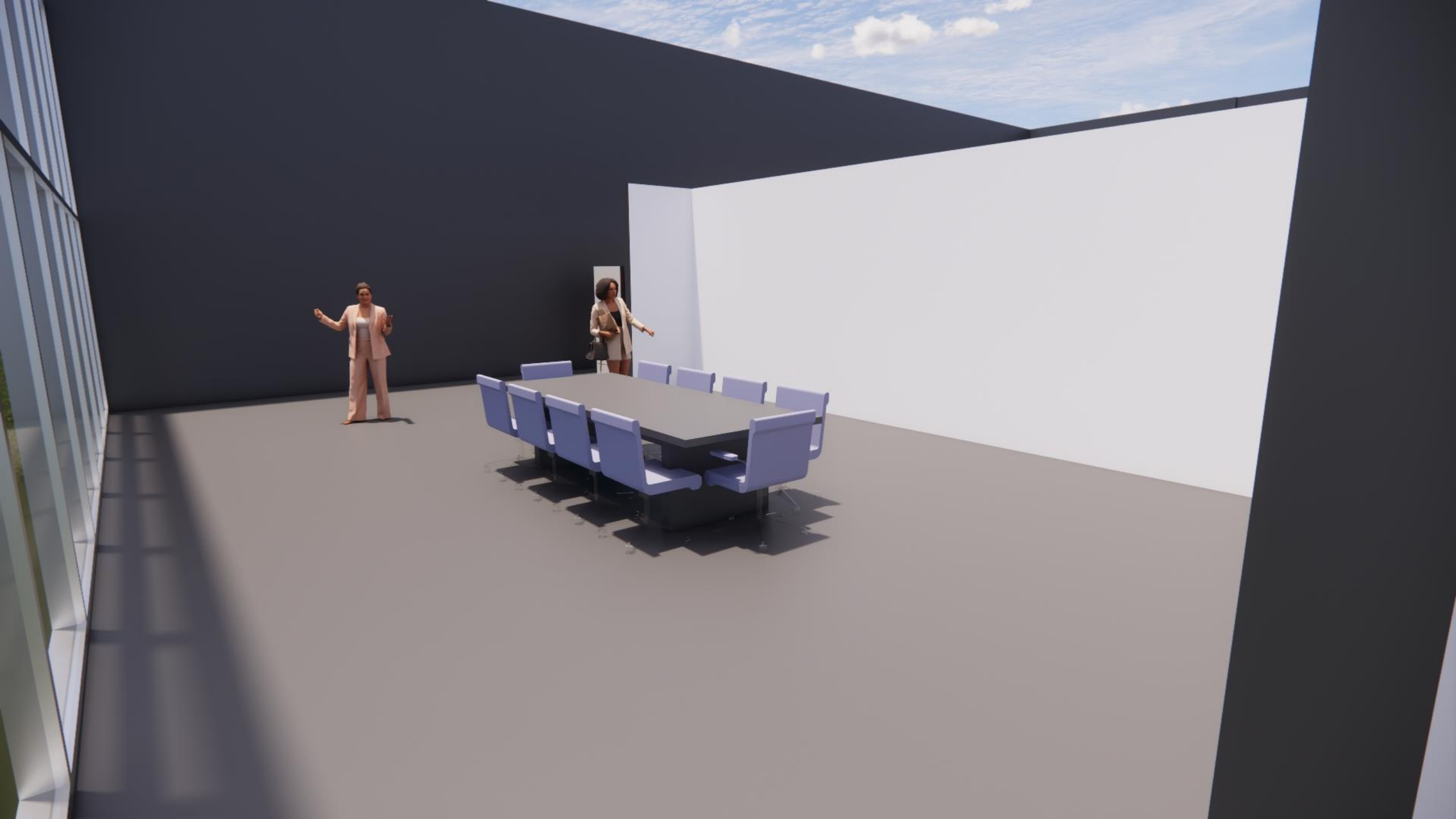

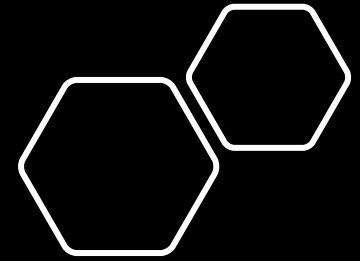
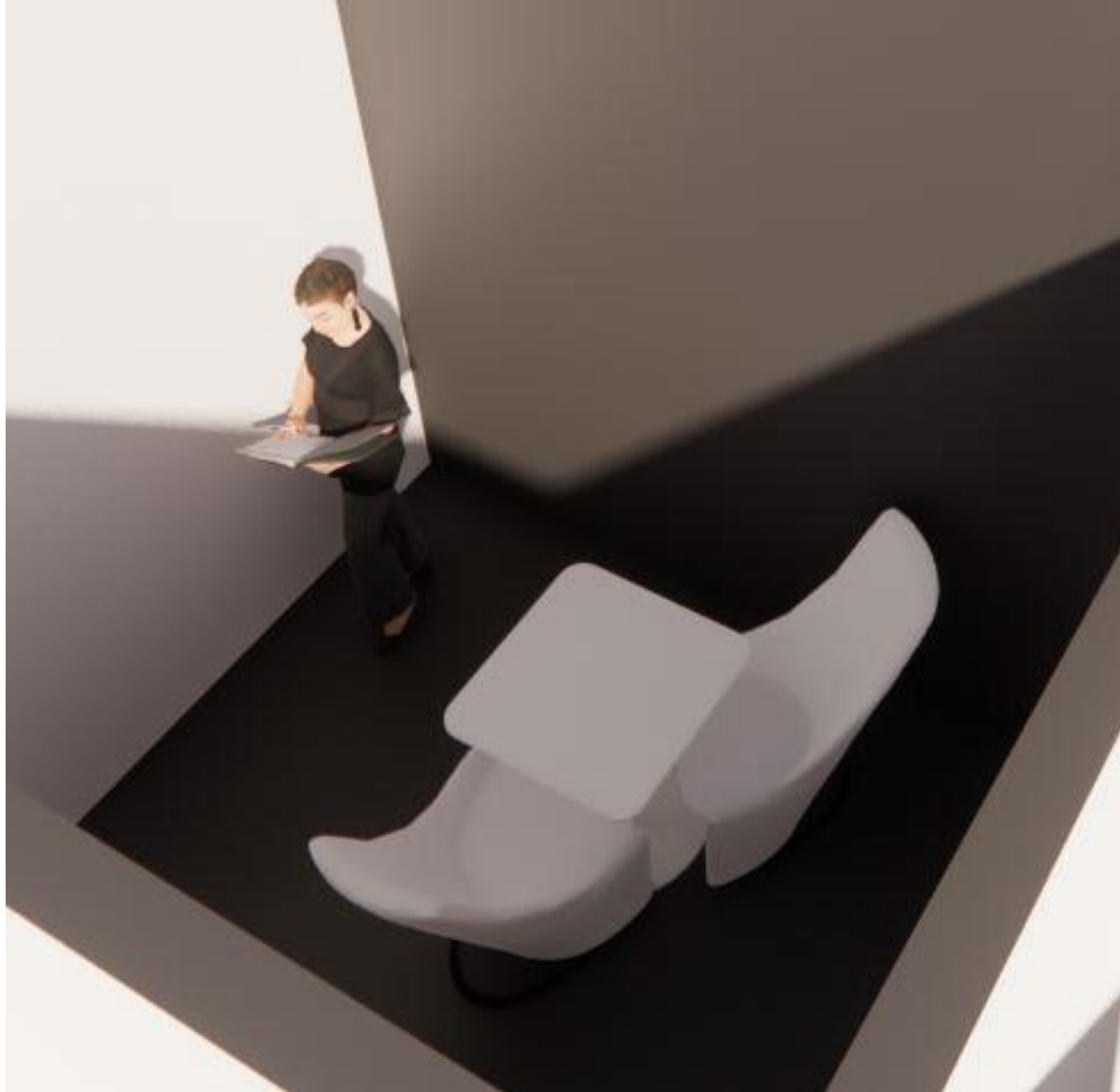













Autism Pederastic Office



Relationship diagrams

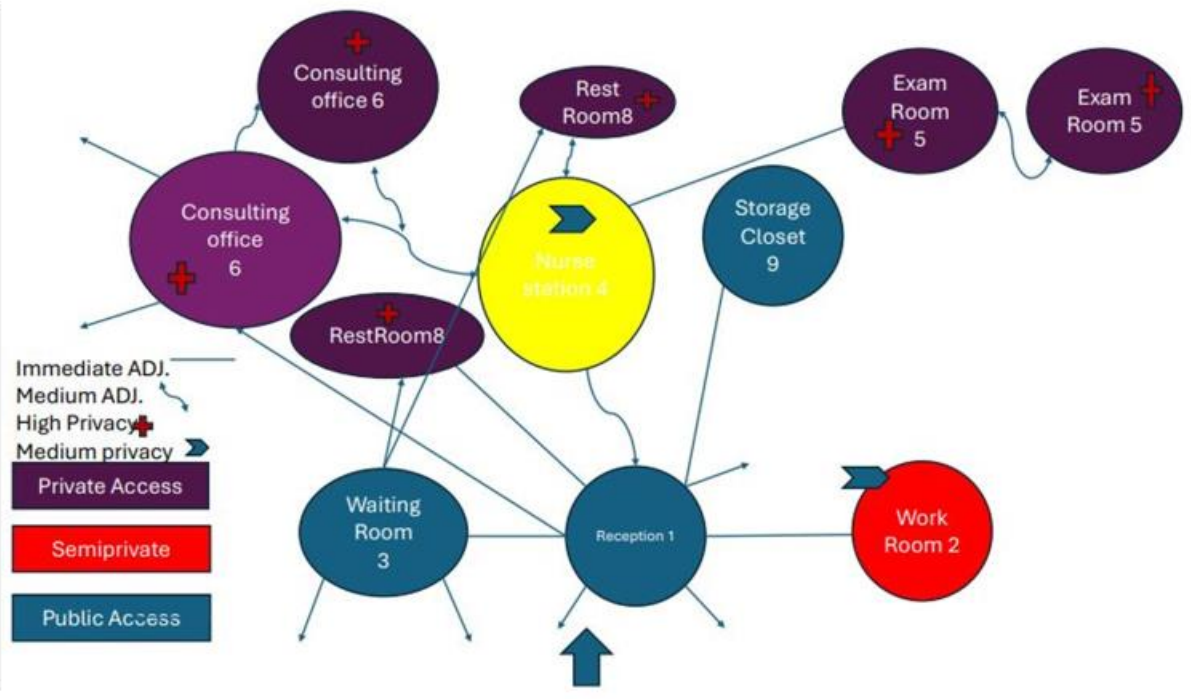
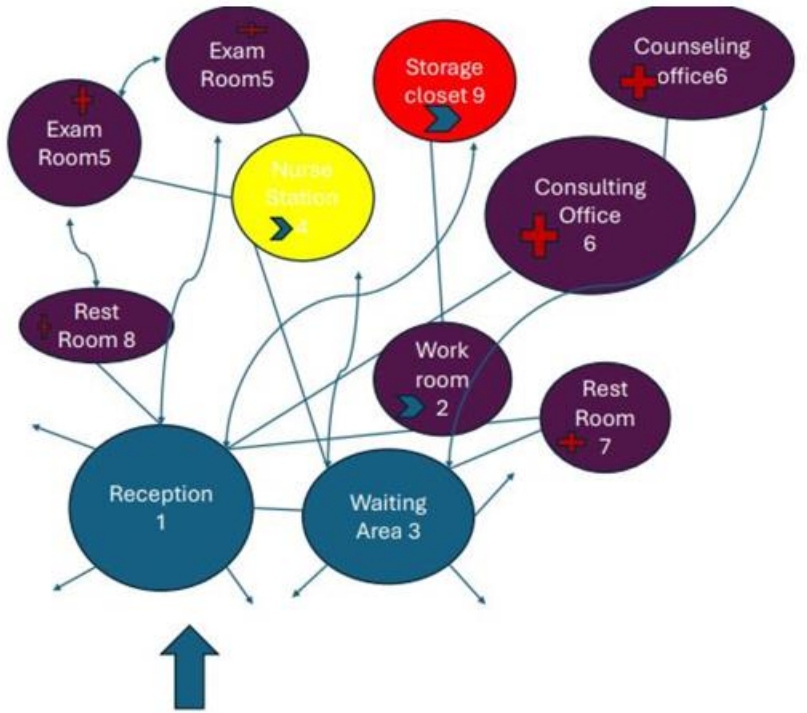

Prototypicals

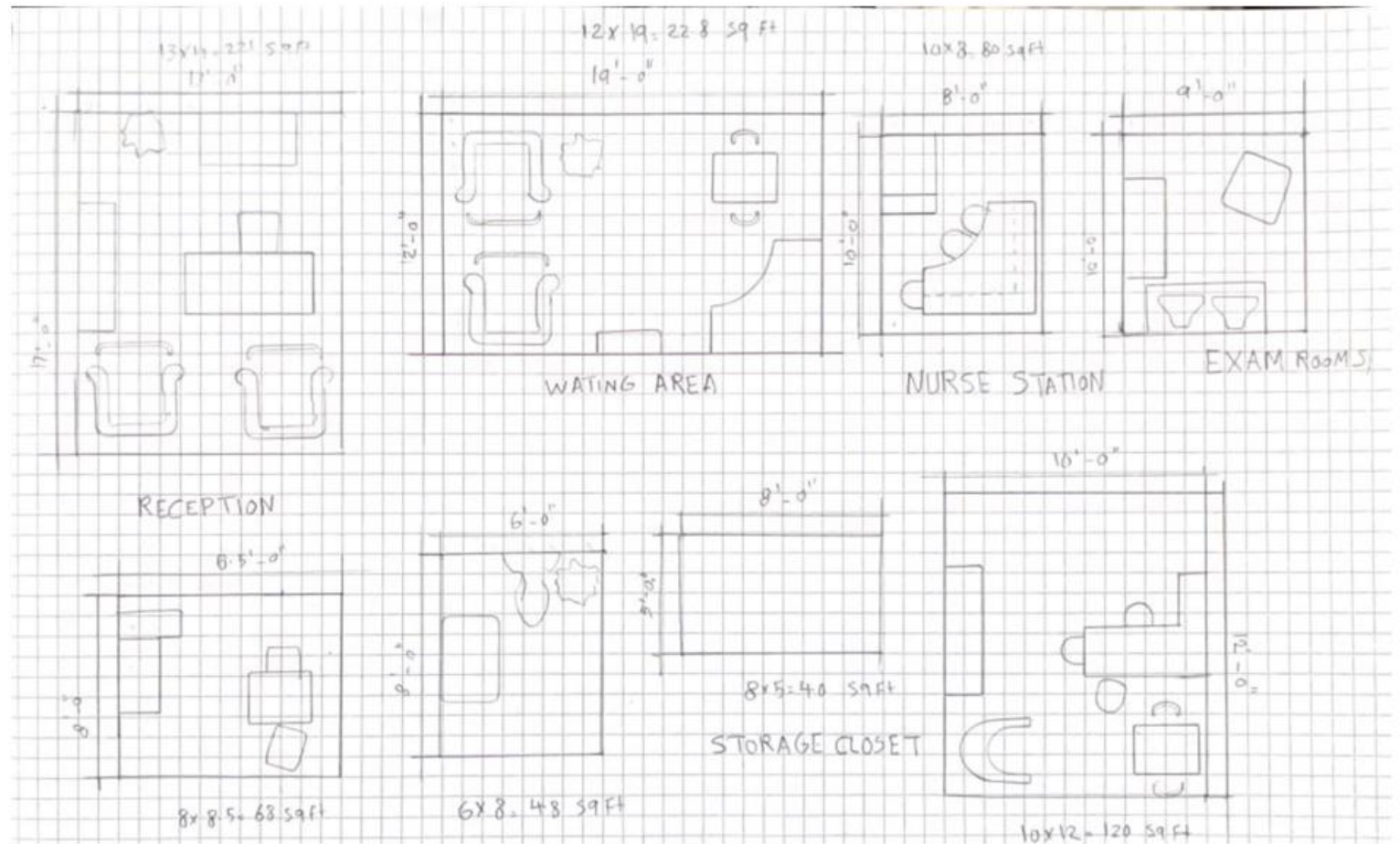

Bubble/block diagrams



Public
Private
Semi-private
FLOOR PLAN



Public
Private
Semi-private
FLOOR PLAN

Final
rendered
floor plan

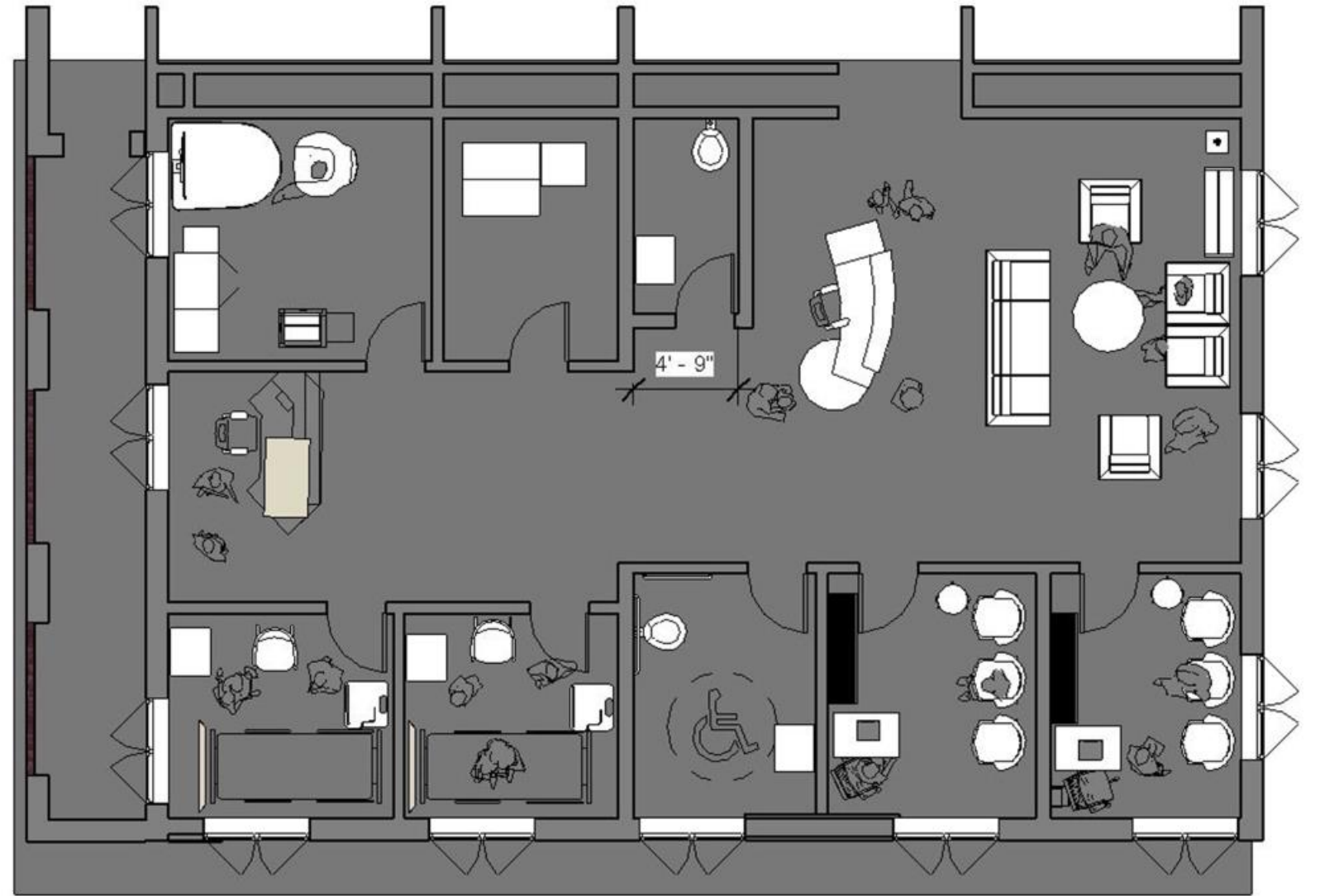

Floor Plan
Top view

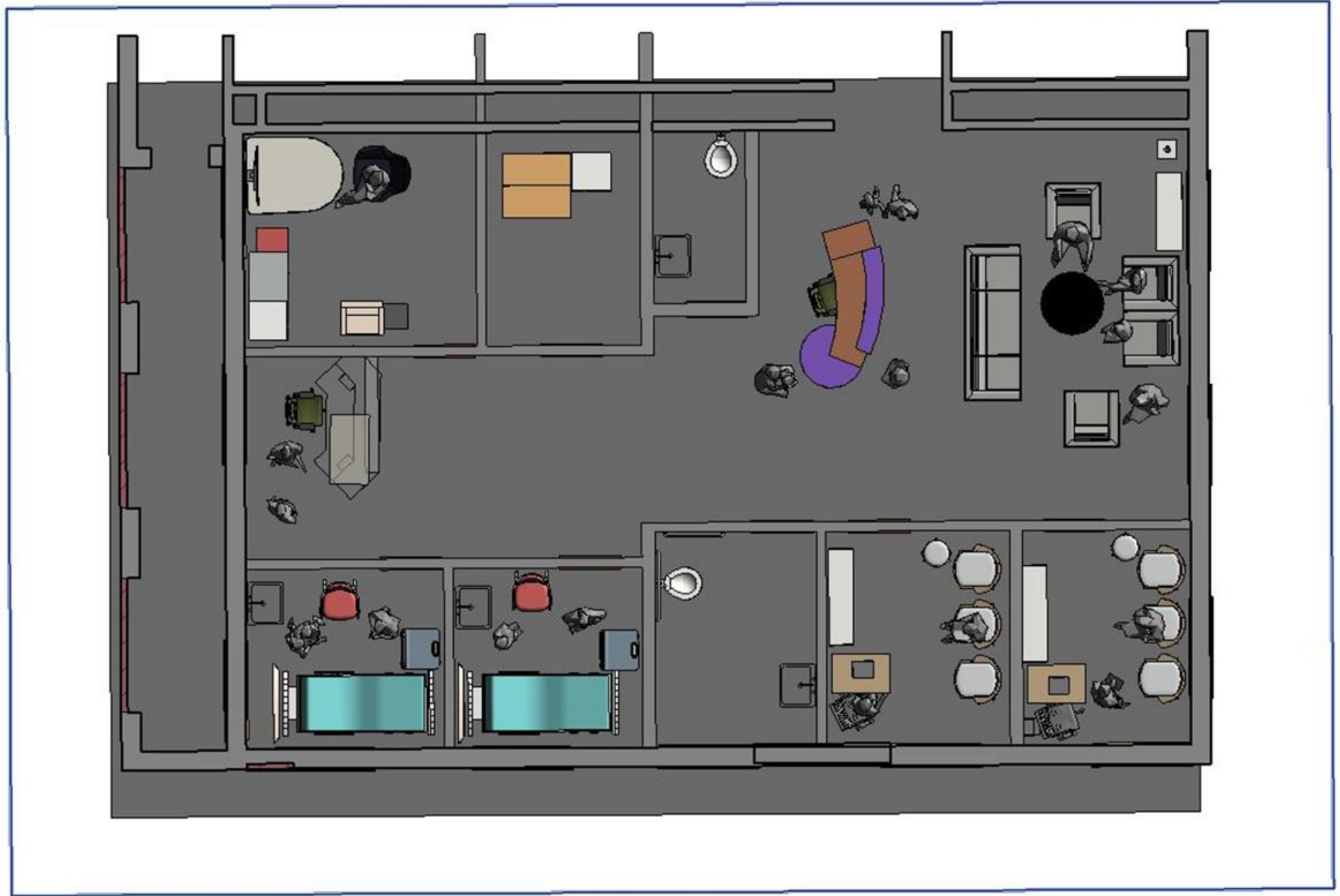

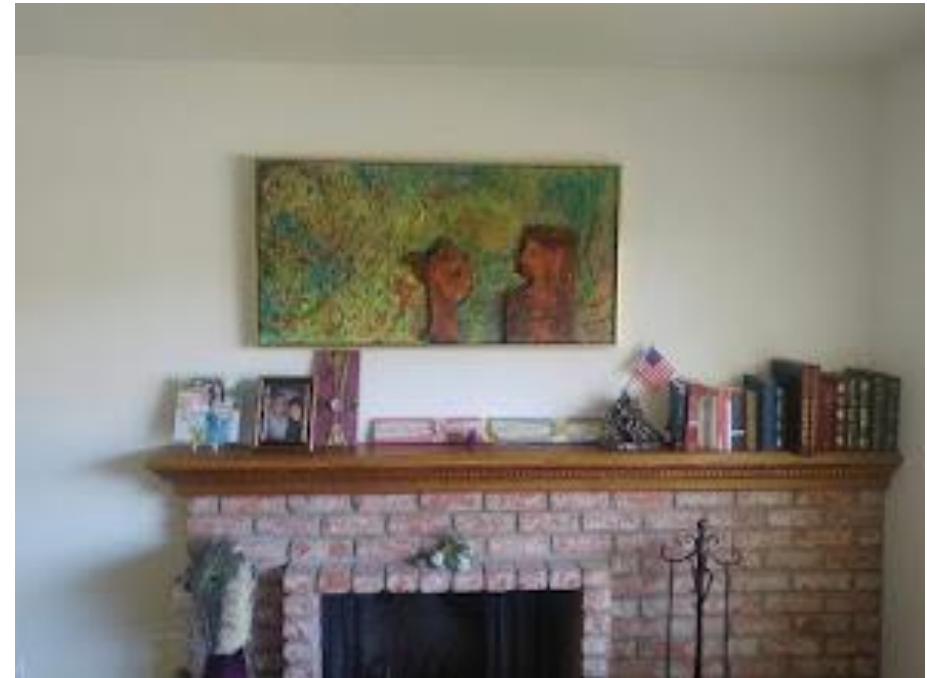
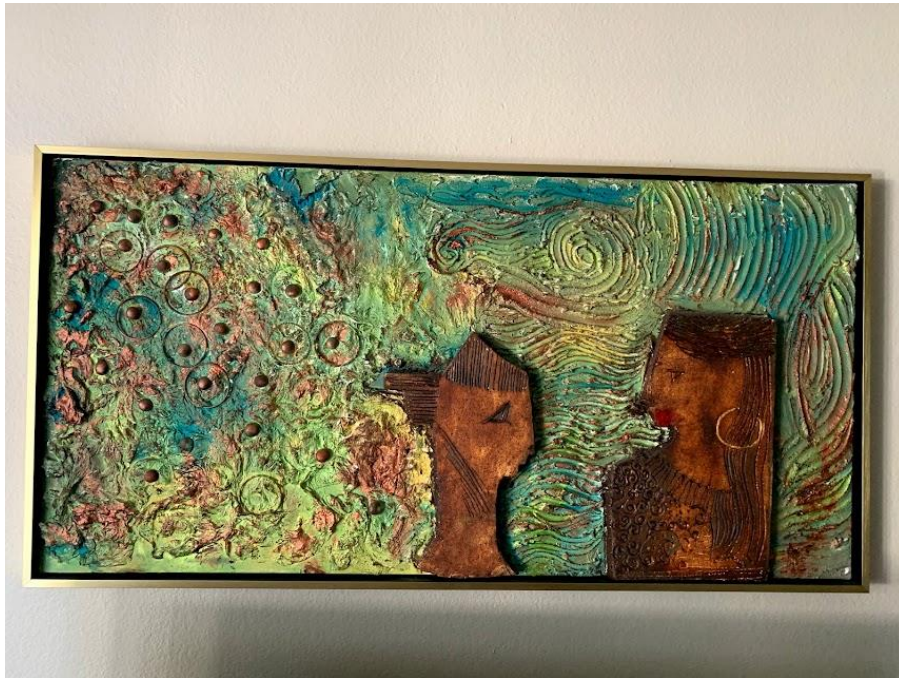

3D Art Panel For Interior

Reception

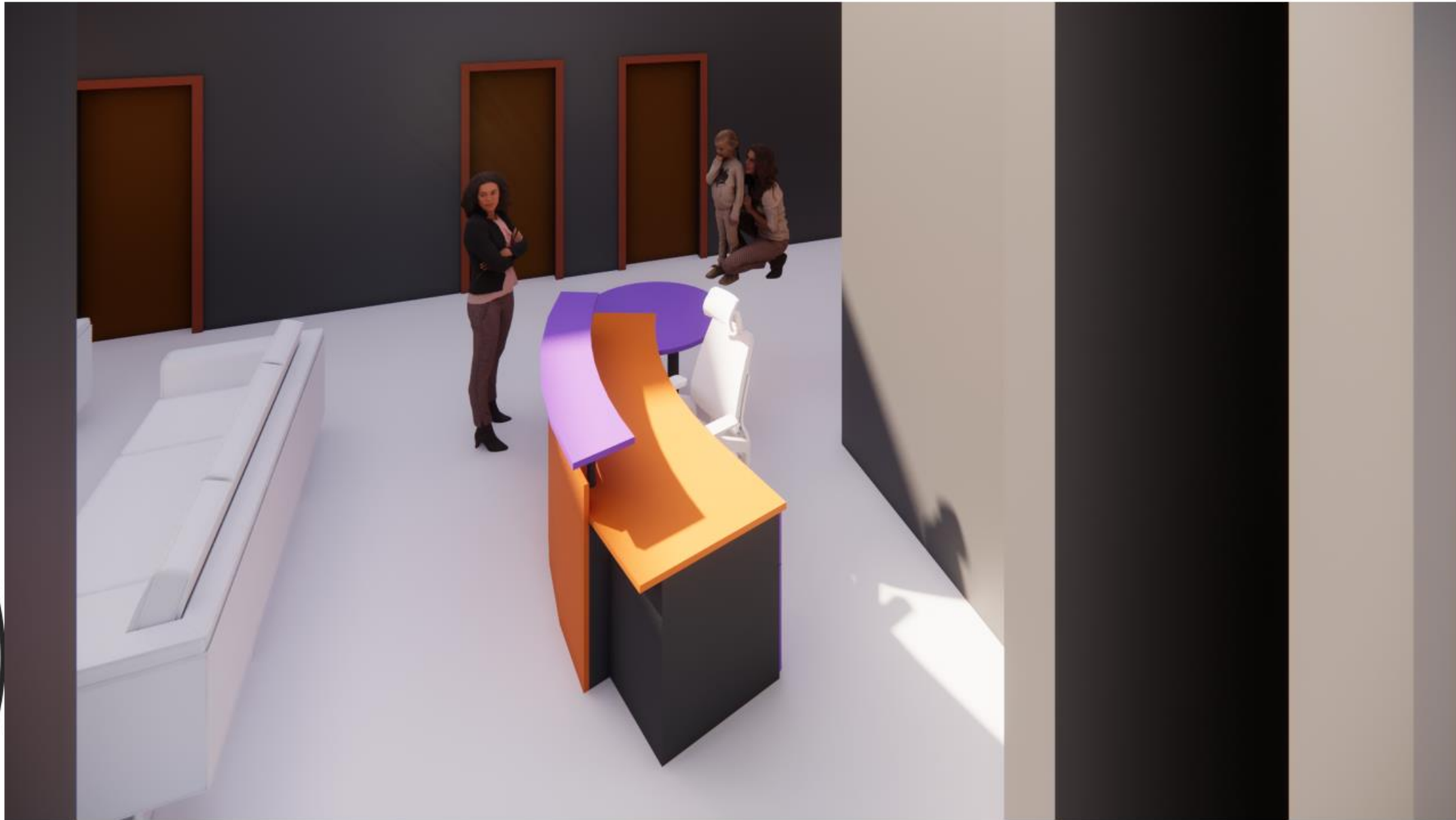



Waiting
Room Area





Consultation
Office 1

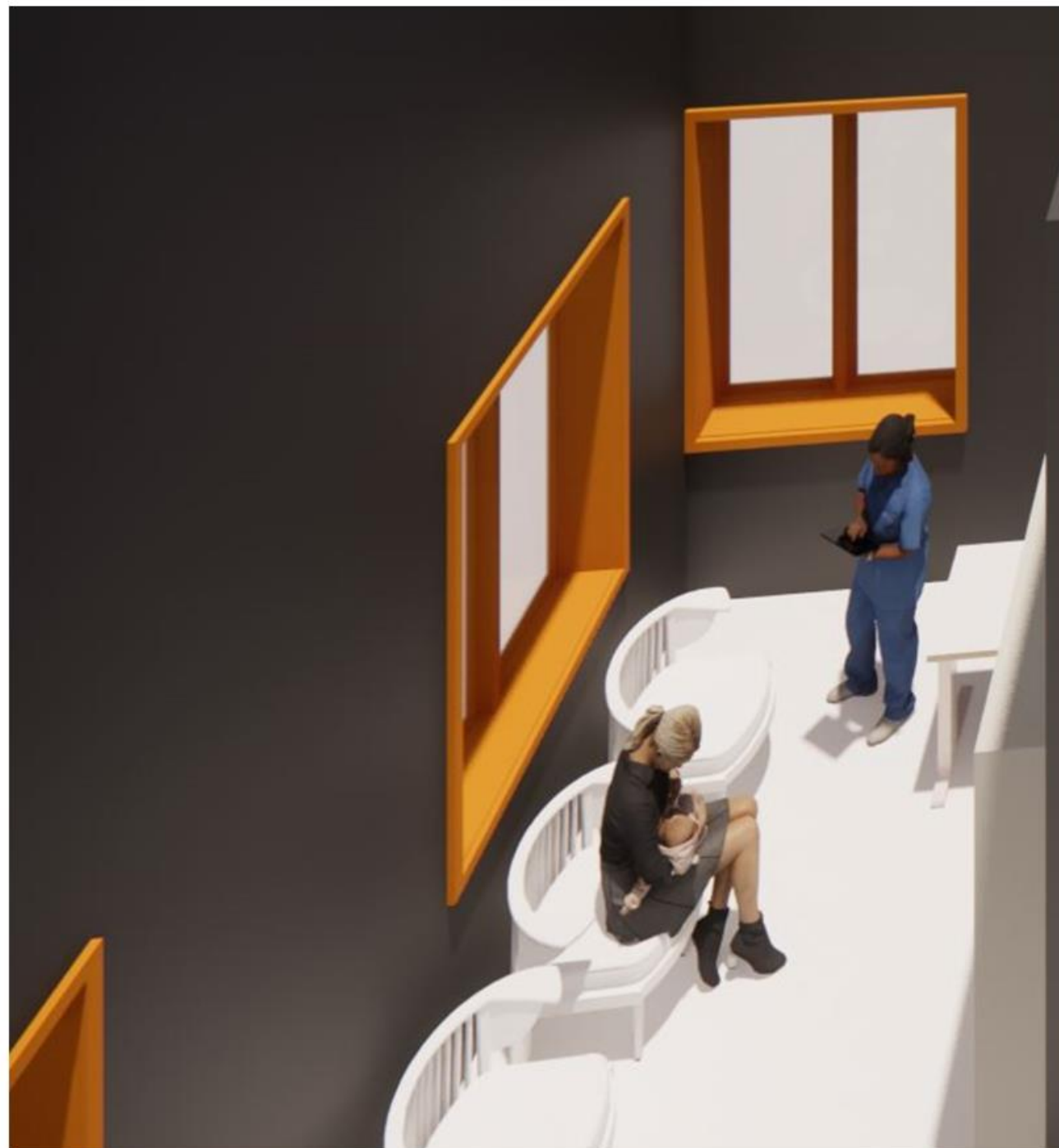



Consultation
office 2





Exam Room 1



Exam Room
2



Work room



Nurse
Station



Storage

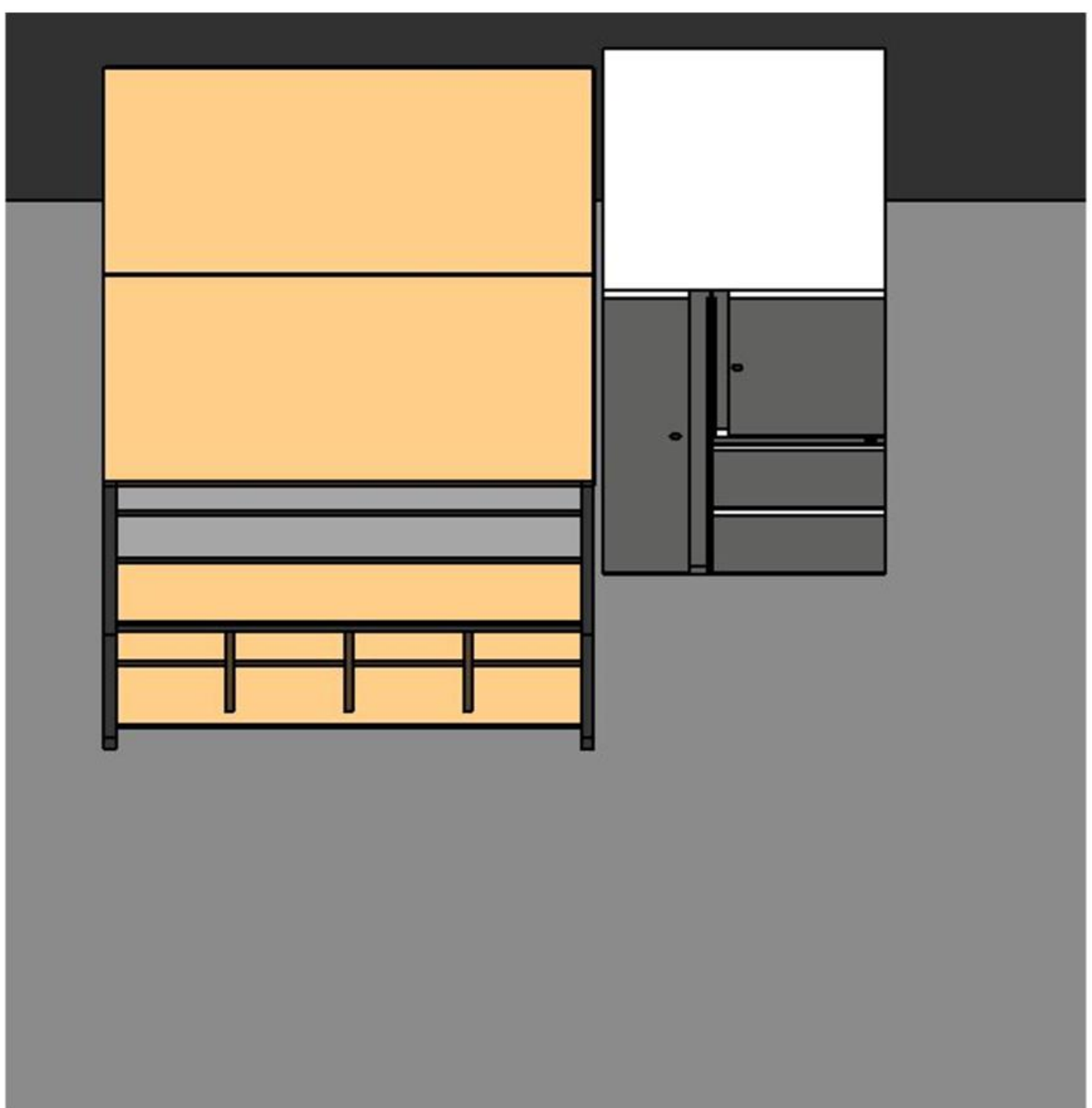

Ada
Restroom



Pediatric
Reception
Desk











Chistadesign

The End

